

TDS3000C Series
Digital Phosphor Oscilloscopes
User Manual

Revision A

www.tektronix.com
071-2308-00

Tektronix

Copyright © Tektronix. All rights reserved. Licensed software products are owned by Tektronix or its subsidiaries or suppliers, and are protected by national copyright laws and international treaty provisions.

Tektronix products are covered by U.S. and foreign patents, issued and pending. Information in this publication supersedes that in all previously published material. Specifications and price change privileges reserved.

TEKTRONIX and TEK are registered trademarks of Tektronix, Inc.

TEKPROBE, and TekSecure are registered trademarks of Tektronix, Inc.

DPX, WaveAlert, e*Scope, and OpenChoice are trademarks of Tektronix, Inc.

Contacting Tektronix

Tektronix, Inc.
14200 SW Karl Braun Drive
P.O. Box 500
Beaverton, OR 97077
USA

For product information, sales, service, and technical support:

- In North America, call 1-800-833-9200.
- Worldwide, visit www.tektronix.com to find contacts in your area.

Warranty 16

Tektronix warrants that the product will be free from defects in materials and workmanship for a period of three (3) years from the date of original purchase from an authorized Tektronix distributor. If the product proves defective during this warranty period, Tektronix, at its option, either will repair the defective product without charge for parts and labor, or will provide a replacement in exchange for the defective product. Batteries are excluded from this warranty. Parts, modules and replacement products used by Tektronix for warranty work may be new or reconditioned to like new performance. All replaced parts, modules and products become the property of Tektronix.

In order to obtain service under this warranty, Customer must notify Tektronix of the defect before the expiration of the warranty period and make suitable arrangements for the performance of service. Customer shall be responsible for packaging and shipping the defective product to the service center designated by Tektronix, shipping charges prepaid, and with a copy of customer proof of purchase. Tektronix shall pay for the return of the product to Customer if the shipment is to a location within the country in which the Tektronix service center is located. Customer shall be responsible for paying all shipping charges, duties, taxes, and any other charges for products returned to any other locations.

This warranty shall not apply to any defect, failure or damage caused by improper use or improper or inadequate maintenance and care. Tektronix shall not be obligated to furnish service under this warranty a) to repair damage resulting from attempts by personnel other than Tektronix representatives to install, repair or service the product; b) to repair damage resulting from improper use or connection to incompatible equipment; c) to repair any damage or malfunction caused by the use of non-Tektronix supplies; or d) to service a product that has been modified or integrated with other products when the effect of such modification or integration increases the time or difficulty of servicing the product.

THIS WARRANTY IS GIVEN BY TEKTRONIX WITH RESPECT TO THE PRODUCT IN LIEU OF ANY OTHER WARRANTIES, EXPRESS OR IMPLIED. TEKTRONIX AND ITS VENDORS DISCLAIM ANY IMPLIED WARRANTIES OF MERCHANTABILITY OR FITNESS FOR A PARTICULAR PURPOSE. TEKTRONIX' RESPONSIBILITY TO REPAIR OR REPLACE DEFECTIVE PRODUCTS IS THE SOLE AND EXCLUSIVE REMEDY PROVIDED TO THE CUSTOMER FOR BREACH OF THIS WARRANTY. TEKTRONIX AND ITS VENDORS WILL NOT BE LIABLE FOR ANY INDIRECT, SPECIAL, INCIDENTAL, OR CONSEQUENTIAL DAMAGES IRRESPECTIVE OF WHETHER TEKTRONIX OR THE VENDOR HAS ADVANCE NOTICE OF THE POSSIBILITY OF SUCH DAMAGES.

Table of Contents

General Safety Summary	iii
Environmental Considerations	vi
Preface.....	ix
Getting Started	1
Initial Setup	1
Product and Feature Description	5
Transporting the Oscilloscope.....	9
Operating Positions	10
Connecting Power.....	10
Installing an Application Module	15
Installing the Communication Module	16
Front-Panel Menus and Controls.....	17
Front-Panel Connectors.....	28
Rear-Panel Connectors.....	29
Communication Module Connectors	30
Application Examples.....	31
Taking Simple Measurements	31
Analyzing Signal Detail	38
Taking FFT Measurements	45
Triggering on a Video Signal.....	47
Capturing a Single-Shot Signal	51
Saving Data to a USB Flash Drive.....	54
Reference.....	59
Acquisition Controls	59
Cursor	70
Display	75
Hard Copy	78
Horizontal Controls	80
Math and FFT.....	86
Measure	95
QuickMenu	100
Save/Recall	101

Trigger Controls	108
Utility	132
Vertical Controls	139
e*Scope Web-Based Remote Control	143
Appendix A: Specifications	149
Certifications and Compliances	160
Appendix B: Factory Setup	165
Appendix C: Accessories	169
Appendix D: Probe Basics	173
Probe Descriptions	173
Probe Compensation	174
TekProbe Interface	174
Probe Guard	174
Ground Leads	175
P3010 High-Frequency Compensation	176
P3010 Replaceable Parts and Accessories	177
P6139A Replaceable Parts and Accessories	178
Using Other Probes	180
Supported Active Probes and Adapters	180
Unsupported Probes	181
Appendix E: General Care and Cleaning	183
Appendix F: Ethernet Setup	185
Your Ethernet Network Information	185
Entering the Ethernet Network Settings	186
Entering the Network Printer Settings	187
Testing Your Ethernet Connection	188
Troubleshooting Your Ethernet Connection	190
The Instrument Setup Screen	190
The Printer Configuration Screen	192
The Add Printer Screen	193
Ethernet Error Messages	195
Ethernet Settings Form	196

Index

General Safety Summary

Review the following safety precautions to avoid injury and prevent damage to this product or any products connected to it.

To avoid potential hazards, use this product only as specified.

Only qualified personnel should perform service procedures.

To Avoid Fire or Personal Injury

Use Proper Power Cord. Use only the power cord specified for this product and certified for the country of use.

Connect and Disconnect Properly. Connect the probe output to the measurement instrument before connecting the probe to the circuit under test. Connect the probe reference lead to the circuit under test before connecting the probe input. Disconnect the probe input and the probe reference lead from the circuit under test before disconnecting the probe from the measurement instrument.

Ground the Product. This product is grounded through the grounding conductor of the power cord. To avoid electric shock, the grounding conductor must be connected to earth ground. Before making connections to the input or output terminals of the product, ensure that the product is properly grounded.

Observe All Terminal Ratings. To avoid fire or shock hazard, observe all ratings and markings on the product. Consult the product manual for further ratings information before making connections to the product.

Connect the probe reference lead to earth ground only.

Do Not Operate Without Covers. Do not operate this product with covers or panels removed.

Do Not Operate With Suspected Failures. If you suspect that there is damage to this product, have it inspected by qualified service personnel.

Avoid Exposed Circuitry. Do not touch exposed connections and components when power is present.

Replace Batteries Properly. Replace batteries only with the specified type and rating.

Recharge Batteries Properly. Recharge batteries for the recommended charge cycle only.

Do Not Operate in Wet/Damp Conditions.

Do Not Operate in an Explosive Atmosphere.

Keep Product Surfaces Clean and Dry.

Provide Proper Ventilation. Refer to the manual's installation instructions for details on installing the product so it has proper ventilation.

Terms in this Manual

These terms may appear in this manual:



WARNING. *Warning statements identify conditions or practices that could result in injury or loss of life.*



CAUTION. *Caution statements identify conditions or practices that could result in damage to this product or other property.*

Symbols and Terms on the Product

These terms may appear on the product:

- DANGER indicates an injury hazard immediately accessible as you read the marking.
- WARNING indicates an injury hazard not immediately accessible as you read the marking.
- CAUTION indicates a hazard to property including the product.

The following symbol(s) may appear on the product:



WARNING
High Voltage



Protective Ground
(Earth) Terminal



CAUTION
Refer to Manual

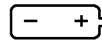

Battery
Information



Ethernet Port



Chassis Ground

Environmental Considerations

This section provides information about the environmental impact of the product.

Product End-of-Life Handling

Observe the following guidelines when recycling an instrument or component:

Equipment Recycling. Production of this equipment required the extraction and use of natural resources. The equipment may contain substances that could be harmful to the environment or human health if improperly handled at the product's end of life. In order to avoid release of such substances into the environment and to reduce the use of natural resources, we encourage you to recycle this product in an appropriate system that will ensure that most of the materials are reused or recycled appropriately.



This symbol indicates that this product complies with the European Union's requirements according to Directive 2002/96/EC on waste electrical and electronic equipment (WEEE). For information about recycling options, check the Support/Service section of the Tektronix Web site (www.tektronix.com).

Battery Recycling. This product may contain a lithium ion (Li-ion) rechargeable battery, which must be recycled or disposed of properly. Please properly dispose of or recycle the battery according to local government regulations.

Mercury Notification. This product uses an LCD backlight lamp that contains mercury. Disposal may be regulated due to environmental considerations. Please contact your local authorities or, within the United States, the Electronics Industries Alliance (www.eiae.org) for disposal or recycling information.

Transporting Batteries

The optional lithium ion rechargeable battery pack in this product contains less than 8 grams of equivalent lithium content, with individual cells containing less than 1.5 grams of equivalent lithium, as measured by International Civil Aviation Organization (ICAO) standards. Consult your air carrier for applicability and determination of any special lithium ion battery transportation requirements.

Restriction of Hazardous Substances

This product has been classified as Monitoring and Control equipment, and is outside the scope of the 2002/95/EC RoHS Directive.

Preface

This manual contains operating information for the TDS3000C Series Digital Storage Oscilloscopes. The manual consists of the following chapters:

- The *Getting Started* chapter briefly describes features of the oscilloscope and provides installation instructions.
- The *Application Examples* chapter provides examples on how to solve a variety of measurement problems.
- The *Reference* chapter describes the selections or available range of values for each option.
- The *Appendix A: Specifications* chapter includes electrical, environmental, and physical specifications for the oscilloscope, as well as certifications and compliances.
- The *Appendix B: Factory Setup* chapter contains a list of the menus and controls with the default settings that the oscilloscope recalls when you push the Save/Recall front-panel button, and then the Recall Factory Setup screen button.
- The *Appendix C: Accessories* chapter briefly describes standard and optional accessories.
- The *Appendix D: Probe Basics* chapter provides basic information on the P3010 and the P6139A probes, and on other probes.
- The *Appendix E: Cleaning* chapter describes how to take care of the oscilloscope.
- The *Appendix F: Ethernet Setup* chapter describes how to set up the oscilloscope for printing through the network, and remote programming.

Preventing Electrostatic Damage



CAUTION. *Electrostatic discharge (ESD) can damage components in the oscilloscope and its accessories. To prevent, ESD, observe these precautions when directed to do so.*

Use a Ground Strap. Wear a grounded, antistatic wrist strap to discharge the static voltage from your body while installing or removing sensitive components.

Use a Safe Work Area. Do not use any devices capable of generating or holding a static charge in the work area where you install or remove sensitive components. Avoid handling sensitive components in areas that have a floor or benchtop surface capable of generating a static charge.

Handle Components Safely. Do not slide sensitive components over any surface. Do not touch exposed connector pins. Handle sensitive components as little as possible.

Transport and Store Carefully. Transport and store sensitive components in a static-protected bag or container.

Firmware Updates Through the Internet

If a newer version of firmware becomes available, you can use the Internet and a USB flash drive to update your oscilloscope.

To update the firmware, follow these steps:

1. From your computer, access the www.tektronix.com Web site and check if a newer version of oscilloscope firmware is available.

If there is a newer version of firmware, download the firmware file from the web page. Unzip and copy the **tds3000c.img** file into the root folder of a USB flash drive.

2. Power off your oscilloscope.
3. Insert the USB flash drive into the flash drive port on the front of the oscilloscope.
4. Power on your oscilloscope.
5. When prompted, push the **OK Load New Firmware** menu button to start the firmware load process.

NOTE. *Do not power off the oscilloscope or remove the USB flash drive until the oscilloscope finishes installing the firmware.*

6. Wait for the oscilloscope to reboot itself.
7. When prompted, remove the USB flash drive.
8. Push the **Utility** front-panel button.
9. Push the **Version** bottom button. The oscilloscope displays the firmware version number.
10. Confirm that the version number matches that of the new firmware.

Getting Started

In addition to a product and feature description, this chapter covers the following topics:

- How to perform a quick functional check, install and compensate passive probes, compensate the signal path, and set the time and date
- How to install the power cord, battery pack, and operate the oscilloscope safely with battery power
- How to install application modules and the communication module
- How to use the menu system
- How to identify the oscilloscope controls and connectors

Initial Setup

The following procedures describe how to quickly verify that the oscilloscope is powering up and functioning correctly, compensate passive probes using the built-in compensation signal, run the signal path compensation (SPC) routine for maximum signal accuracy, and set the time and date.

- You should perform all initial setup procedures the first time you use the oscilloscope.
- You should perform the probe compensation procedure whenever you attach a passive probe for the first time to any input channel.
- You should run the signal path compensation routine whenever the ambient temperature changes by 10 °C (18 °F) or more.

Functional Check

Perform this quick functional check to verify that your oscilloscope is operating correctly.

1. Connect the oscilloscope power cable. (See page 10.)

2. Power on the oscilloscope.
Wait for the confirmation that all self tests have passed.

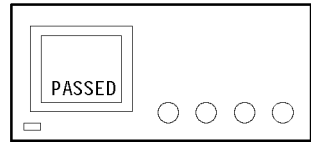

OnStandby
button

3. Connect the oscilloscope probe to channel 1. Attach the probe tip and reference lead to the **Probe Comp** connectors.

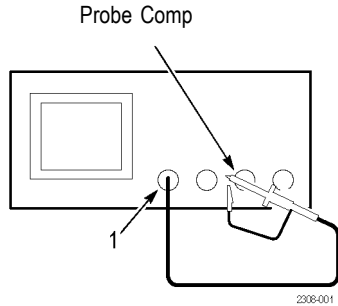

4. Push the **Autoset** button. You should see a square wave in the display (approximately 5 V at 1 kHz).

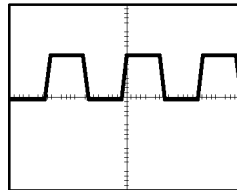

Probe Compensation

Perform this adjustment to match your probe to the input channel. This should be done whenever you attach a passive probe for the first time to any input channel.

1. Connect the oscilloscope probe to channel 1. Attach the probe tip and reference lead to the **Probe Comp** connectors, then push **Autoset**.

If using the probe hook-tip, ensure a proper connection by firmly twisting the tip onto the probe.

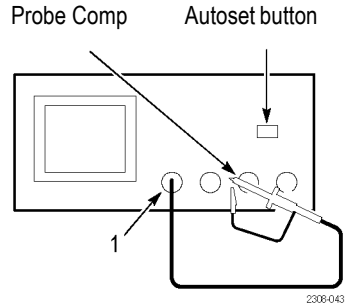

2. Check the shape of the displayed waveform.



Over compensated



Under compensated



Compensated correctly

3. If necessary, adjust your probe.

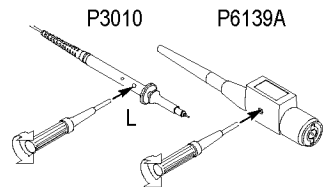

NOTE. See Appendix D: Probe Basics for more information about the probes provided with your oscilloscope.

Signal Path Compensation (SPC)

The SPC routine optimizes the oscilloscope signal path for maximum measurement accuracy. You can run the routine anytime but you should always run the routine if the ambient temperature changes by 10 °C (18 °F) or more.

To compensate the signal path, follow these steps:

1. Disconnect any probes or cables from the channel input connectors.
2. Push the **Utility** button.
3. Push the **System** screen button to select **Cal**.
4. Push the **Signal Path** screen button.
5. Push **OK Compensate Signal Path**. This procedure takes several minutes to complete.

NOTE. *The signal path compensation does not include calibration to the probe tip.*

Adjusting the Oscilloscope Time and Date

To set your oscilloscope to the current date and time, follow these steps:

1. Push the **Utility** button.
2. Push the **System** bottom button to select **Config**.
3. Push the **Set Date & Time** bottom button. Use the side menu buttons to set the date and time values.
4. Push the **OK Enter Date/Time** side button to set the oscilloscope date and time.

Product and Feature Description

The TDS3000C series oscilloscopes consist of the following models:

Model	Channels	Bandwidth	Maximum
TDS3012C	2	100 MHz	1.25 GS/s
TDS3014C	4	100 MHz	1.25 GS/s
TDS3032C	2	300 MHz	2.5 GS/s
TDS3034C	4	300 MHz	2.5 GS/s
TDS3052C	2	500 MHz	5 GS/s
TDS3054C	4	500 MHz	5 GS/s

Acquisition Features

WaveAlert Waveform Anomaly Detection. This feature automatically detects anomalous waveforms by comparing the current waveform to the previous waveform. WaveAlert sets how the oscilloscope responds: stop on anomaly, beep on anomaly, and save anomalous waveform to a USB flash drive. It's useful for capturing signal glitches and intermittent waveform errors. (See page 70.)

Separate Digitizers. This feature ensures accurate timing measurements with separate digitizers for each channel. Each digitizer can sample at up to the maximum sample rate; the acquisition on all channels is always concurrent to provide full single-shot bandwidth on each channel.

Normal Acquisition. This feature acquires 10,000 point waveforms to capture horizontal detail, and then you can use the zoom  function to analyze the detail. (See page 67.)

Fast Trigger Acquisition. This feature acquires up to 3,400 waveforms per second (500 point mode) so you can see rapidly changing signals or intermittent signal irregularities. (See page 67.)

Pretrigger. You can capture signals that occur before the trigger point. You can position the trigger point at the beginning of the acquisition, at the end, or at any location in between. (See page 81.)

Delay. You can also delay the acquisition so that it starts after the trigger point. Use delay when you want to acquire the signal at a specific time after the trigger point. (See page 82.)

Peak Detect. This feature allows you to see pulses as narrow as 1 ns even at the slower time base settings. Peak Detect helps you see noise and glitches in your signal. (See page 65.)

Signal Processing Features

Average. You can apply averaging to your signal to remove uncorrelated noise and improve measurement accuracy. (See page 66.)

Envelope. You can use envelope to capture and display the maximum variation of a signal. (See page 66.)

Waveform Math. You can use waveform math to add, subtract, multiply, or divide waveforms. For example, you can use math to analyze differential signals or to calculate a power waveform. (See page 86.)

FFT Analysis. You can use FFT (Fast Fourier Transform) measurements to convert a time-domain signal into its frequency components for analysis. (See page 88.)

Display Features

Color LCD Display. You can identify and differentiate waveforms easily with color coding. Waveforms, readouts, and buttons are color matched to increase productivity and reduce operating errors. (See page 76.)

Digital Phosphor. A Digital Phosphor Oscilloscope can clearly display intensity modulation in your signals. The oscilloscope automatically overlays subsequent acquisitions and then decays them to simulate the writing and decay of the phosphor in the CRT of an analog oscilloscope. This feature results in an intensity-graded waveform display that shows the information contained in the intensity modulation. (See page 61.)

Signal Preview. You can use the preview feature to optimize the control settings when setting up a single-shot acquisition. As you adjust the controls, the adjustments modify the current acquisition to show a preview of how the next acquisition should appear. (See page 63.)

Measurement Features

Cursors. You can use cursors to take simple voltage, time, and frequency measurements. (See page 70.)

Automatic Measurements. You can choose from a list of automatic waveform measurements. (See page 98.) You can customize the measurements by changing reference levels or by adding measurement gating. (See page 95.)

XY Waveform Cursors. You can use cursors to take measurements on XY waveforms. (See page 74.)

Trigger Features

Dual Triggers. You can use the main (A) trigger system alone or add the B trigger to capture more complex events. You can also use the A and B triggers together to set up a wait-for-time or wait-for-events trigger. (See page 110.)

Logic Triggers. You can trigger on a Boolean condition between two signals. You can use logic triggers to analyze problems in digital circuits, or synchronous state machines. (See page 116.)

Pulse Triggers. You can trigger on a signal that meets a timing or threshold condition. You can use pulse triggers to analyze problems in digital circuits, with bus contention, or in bus transceivers, transmission lines, and op-amp circuits. (See page 122.)

Video Trigger. You can trigger on video fields or lines to see a stable display of standard video signals. (See page 130.)

Alternating Trigger. You can sequentially use each active channel as a trigger source, from the lowest-numbered active channel to the highest-numbered active channel. (See page 114.)

Built-In External Trigger. All models have an external trigger input. Four-channel models have the external trigger connector on the back of the oscilloscope. Two-channel models have the external trigger connector on the front panel.

Convenience Features

e*Scope Web-based Remote Control. You can access your TDS3000C oscilloscope through the Internet, from across a room to across the world. (See page 143.)

Built-in Ethernet. You can connect your TDS3000C oscilloscope to a network or the Internet using the built-in 10BaseT Ethernet port, for e*Scope access or printing screen images to network printers. (See page 185.)

Autoset. You can use Autoset to quickly set up the vertical, horizontal, and trigger controls for a usable display. (See page 60.)

Scope QuickMenu. You can use the built-in Scope QuickMenu for simplified oscilloscope operation. (See page 26.)

Single Sequence. One button sets the trigger parameters to the correct settings for a single-shot acquisition (or single-sequence acquisition). (See page 60.)

USB Flash Drive Port. You can use a USB flash drive to store and recall waveforms and setups, as well as upgrade the oscilloscope firmware and install new features. (See page 104.)

Probe Support. You can use the standard probes or choose an optional probe for a specific application. Appendix D provides information and limitations. (See page 173.)

Multilingual User Interface. On-screen menus and messages are in 11 languages. (See page 132.)

Optional Features

Application Modules. You can install application modules to add new test and measurement features. (See page 169.)

Communication Module. You can install the communication module to add RS-232, GPIB, and VGA ports for remote programmability, or to display the oscilloscope screen on a monitor. (See page 16.)

Battery Power. You can install a rechargeable Lithium-Ion battery pack (TDS3BATC) to use the oscilloscope without line power. (See page 11.)

Transporting the Oscilloscope

When transporting the oscilloscope, wrap the cord around the handle as shown next. Use the supplied cord retainer if the power plug does not have a molded-in retainer.

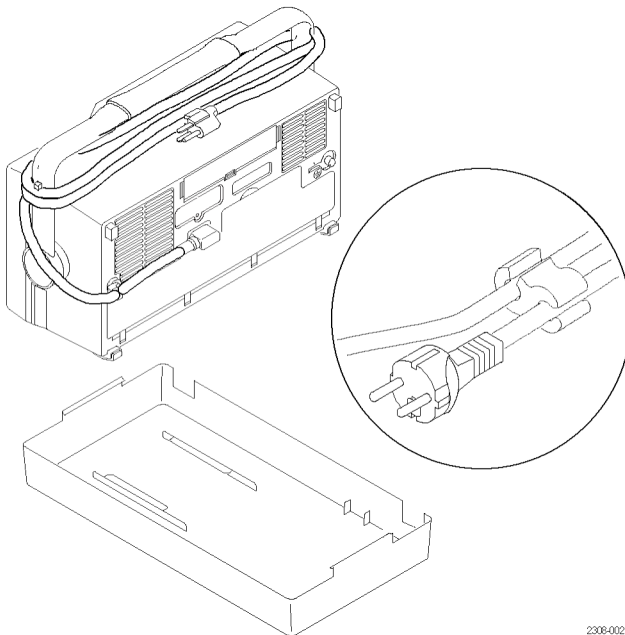

If you are not using a battery, use the accessory tray in the battery compartment to store probes and other accessories.

Operating Positions

Use the handle and feet to place the oscilloscope in a convenient operating position.

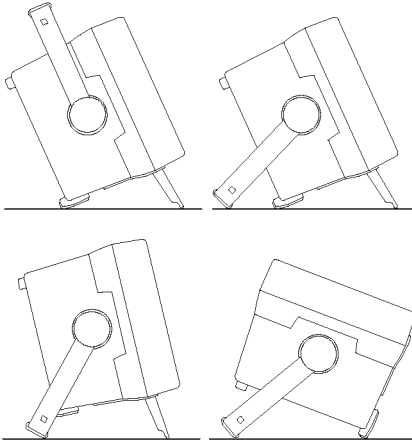

Connecting Power

To connect a power cord, follow these steps:

1. Open the strain relief and slip it over the power cord.
2. Snap the strain relief into its hole in the rear panel of the oscilloscope.
3. Connect the power cord to the power input connector.

You can operate the oscilloscope from a mains supply with line voltage between 90 V_{AC} and 250 V_{AC} and frequency between 47 Hz and 440 Hz. The oscilloscope is grounded through the power cord grounding connector. The line fuse is internal and is not operator replaceable.

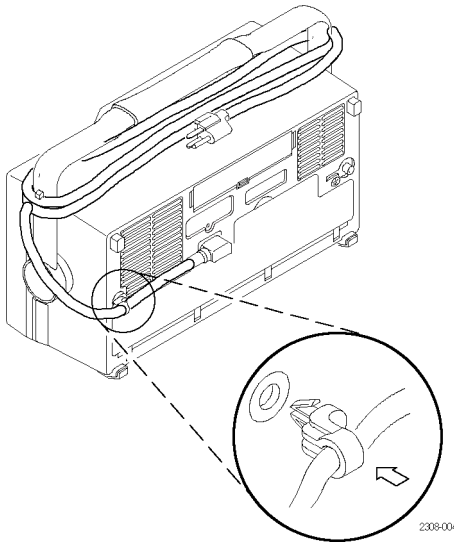

Using Battery Power

You can operate the oscilloscope continuously for approximately three hours from the optional rechargeable TDS3BATC battery pack. A triangle icon in the display \triangle shows when the battery is in use, a power-plug icon $\text{D} \sim$ shows when line power is connected, and a gauge icon $\text{■} \text{□}$ shows the charge level in the battery. The oscilloscope turns off automatically when the battery runs low; the screen may turn white a few minutes before the automatic shutdown.

Refer to the *Environmental Considerations* for information about proper battery disposal. (See page vi.)

Operating Safely with Battery Power



WARNING. To avoid electric shock, connect the rear-panel ground terminal to earth ground when operating the oscilloscope from battery power.

For safe operation, the oscilloscope chassis should always remain at earth ground potential. Without a connection between the chassis and earth ground, you can receive a shock from exposed metal on the chassis if you connect an input to a hazardous voltage ($>30 V_{\text{RMS}}$, $>42 V_{\text{pk}}$). To protect yourself against possible shock, you can attach the Tektronix-supplied grounding wire from the terminal on the rear panel to earth ground. If you use a different grounding wire, it must be at least 18 gauge.

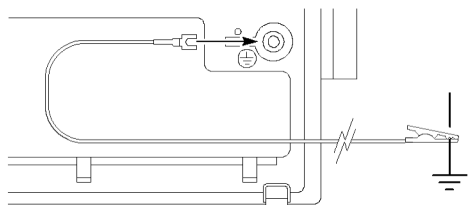

If you choose not to attach the grounding wire, you are not protected against electric shock if you connect the oscilloscope to a hazardous voltage. You can still use the oscilloscope if you do not connect a signal greater than $30 V_{\text{RMS}}$ ($42 V_{\text{pk}}$) to the probe tip, the BNC connector center, or the common lead. Ensure that all probe common leads are connected to the same voltage.



WARNING. Hazardous voltages may exist in unexpected places due to faulty circuitry in the device under test.



CAUTION. When operating the oscilloscope on battery power do not connect a grounded device, such as a printer or computer, to the oscilloscope unless the oscilloscope's grounding wire is connected to the earth ground.

Installing the Battery

To install the optional battery pack, follow these steps:

1. Open the battery compartment door on the rear panel.
2. Remove the accessory tray.

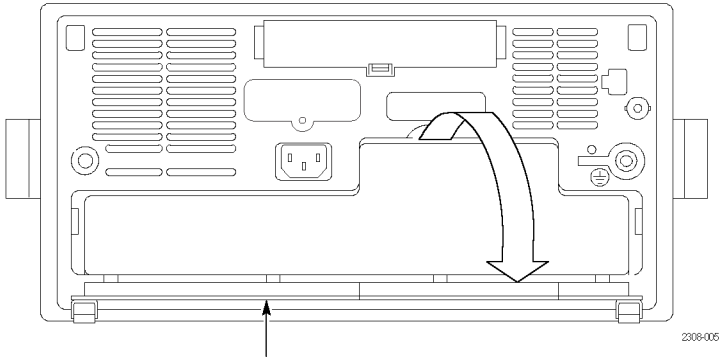

Battery door (opened)

3. Slide the battery into the compartment and press it in from both sides until you hear the latches click.
4. Press on both sides of the battery compartment door to snap it closed.

To remove the battery, follow these steps:

1. Open the battery compartment door.
2. Raise the handles on each side of the battery and use them to pull the battery out of the oscilloscope.

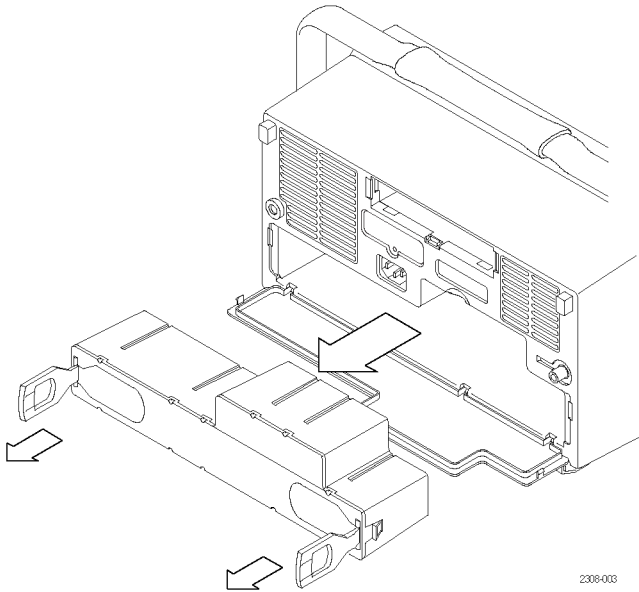

Maximizing Operating Time

To maximize the time that the oscilloscope can operate from a full battery charge, consider doing these things:

- Reduce the display backlight intensity (See page 75.)
- Disconnect unused active probes
- Only use passive probes

Charging the Battery

The battery charges automatically when the oscilloscope is connected to line power. You can also charge the battery with the optional external charger (TDS3CHG).

Configuration	Typical charging time
Battery charging in oscilloscope with oscilloscope turned on or off	32 hours
Battery charging with TDS3CHG external charger	6 hours

NOTE. Charge the battery before using it for the first time or after prolonged storage.

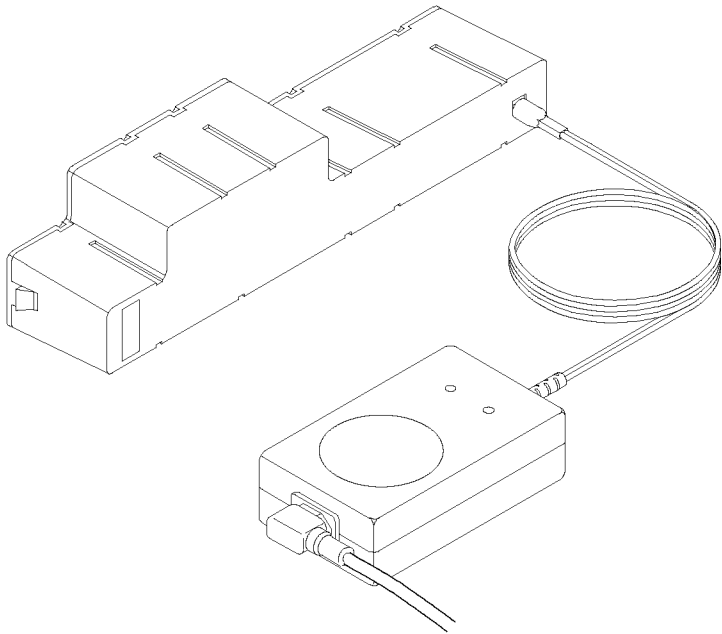

Installing an Application Module



CAUTION. To avoid damage to the oscilloscope or application module, observe the ESD precautions. (See page x.)

Optional application modules are available to extend the capability of your oscilloscope. You can install up to four application modules at one time. Application modules can go into the two slots with windows in the upper right corner of the front panel. Two additional slots are directly behind the two you can see.

Refer to the *TDS3000, TDS3000B, and TDS3000C Series Application Module Installation Manual* that came with your application module for instructions on installing and testing an application module.

NOTE. *If you remove an application module, the features provided by the application module become unavailable. You can reinstall the module to restore the features.*

Installing the Communication Module



CAUTION. *To avoid damage to the oscilloscope or communication module, observe the ESD precautions. (See page x.)*

To install the optional communications module, follow these steps:

1. Turn the oscilloscope power off.
2. Press down on the latching tab to remove the blank cover.
3. Slide the communication module into the compartment until the internal connectors are seated and the latching tab locks.
4. Turn the power on. The communication module is now ready for your use.

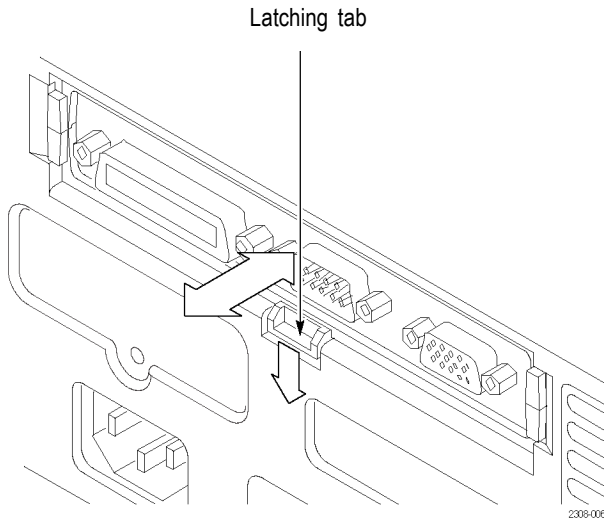

To remove a communication module, follow these steps:

1. Turn the oscilloscope power off.
2. Press down on the latching tab and then use a small screwdriver to alternately pry out the sides of the communication module.
3. Slide out the communication module and store it in an ESD-shielded bag. Install the blank cover.

Communication port	For more information, see
<p> GPIB </p> <p> RS-232 </p>	<p> <i>The TDS3000, TDS3000B, and TDS3000C Series Digital Phosphor Oscilloscopes Programmer Manual, and Hard Copy</i> in this user manual. (See page 78.) </p>
<p> VGA </p>	<p> Specifications for the I/O ports in Appendix A in this user manual. </p>

Front-Panel Menus and Controls

The front panel has buttons and controls for the functions you use most often. The front panel has menus to access more specialized functions.

Using the Menu System

To use the menu system, follow these steps:

1. Push a front-panel menu button to display the menu you want to use.

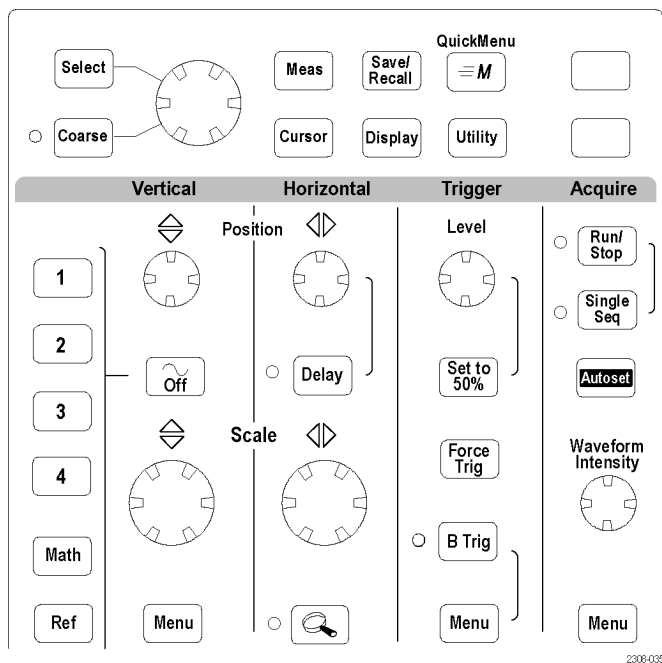

2. Push a bottom screen button to select a menu item. If a pop-up menu appears, continue to push the screen button to select an item from the pop-up menu.

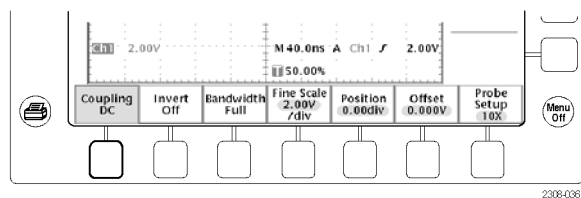

- Push a side screen button to choose a menu item. If the menu item contains more than one choice, push the side screen button again to make the choice.

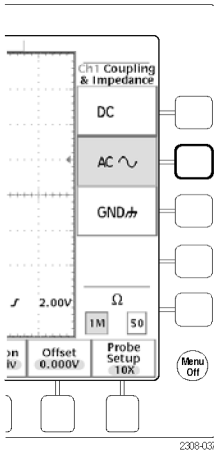

- Certain menu choices require you to set a numerical value to complete the setup. Use the general purpose knob to adjust the parameter value. Push the **Coarse** button to make larger adjustments.

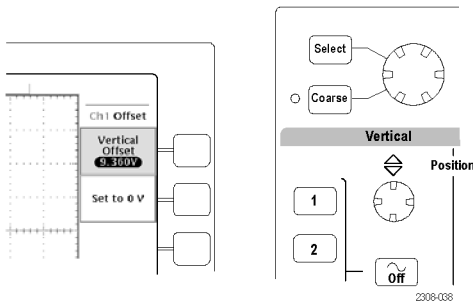

Using the Menu Buttons

You can use the menu buttons to perform many functions in the oscilloscope.

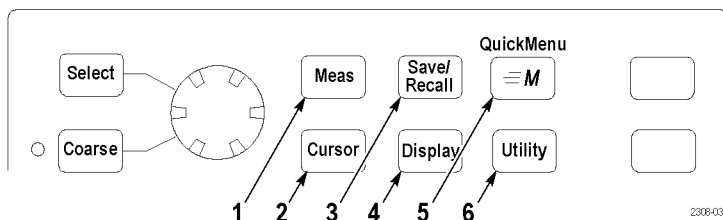

1. **Meas.** Performs automated measurements of waveforms.
2. **Cursor.** Activates the cursors.
3. **Save/Recall.** Saves and recalls setups and waveforms to memory or a USB flash drive.
4. **Display.** Changes the appearance of waveforms and the display screen.
5. **QuickMenu.** Activates QuickMenus such as the built-in Scope QuickMenu.
6. **Utility.** Activates the system utility functions, such as selecting a language.

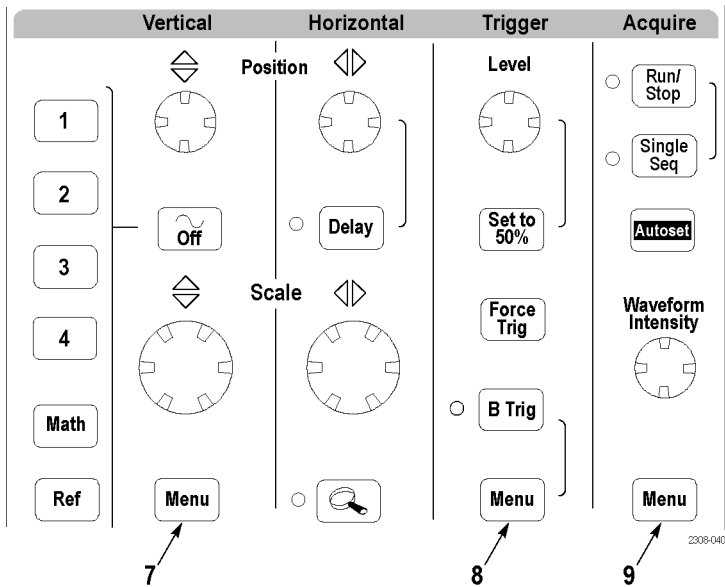

7. Vertical Menu. Adjusts the scale, position, and offset of waveforms. Sets the input parameters.
8. Trigger Menu. Adjusts the trigger functions.
9. Acquire Menu. Sets the acquisition modes and horizontal resolution, and resets the delay time.

Using the Dedicated Controls

These dedicated buttons and controls generally control waveforms and cursors without the use of menus.

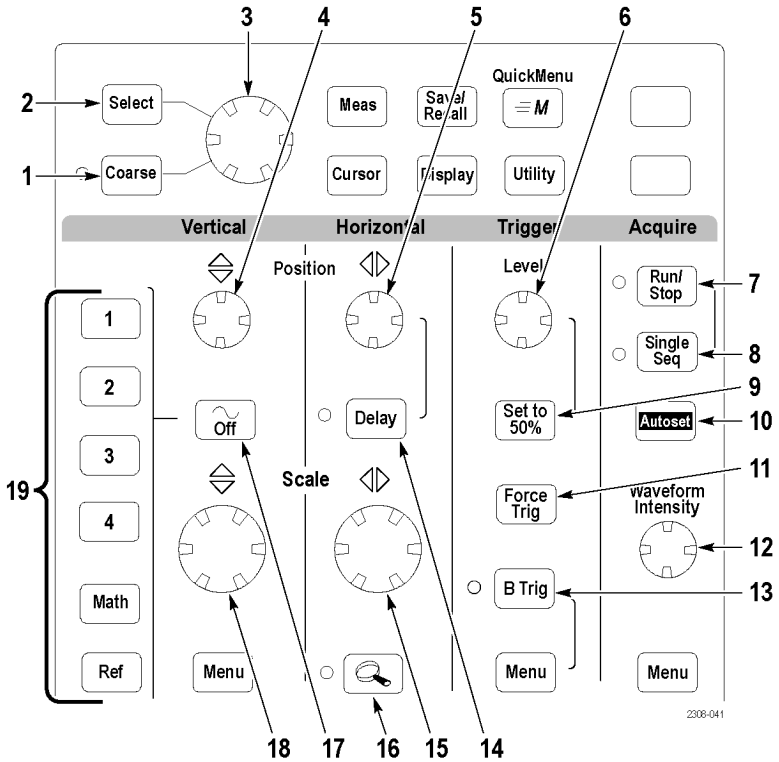

1. Coarse. Causes the general purpose knob and position knobs to make adjustments more quickly.
2. Select. Toggles between the two cursors to select the active cursor.
3. General purpose knob. Moves the cursors. Sets numerical parameter values for some menu items. Push the Coarse button to make adjustments quickly.
4. Vertical Position. Adjusts the vertical position of the selected waveform. Push the Coarse button to make adjustments more quickly.

5. **Horizontal Position.** Adjusts the trigger point location relative to the acquired waveforms. Push the Coarse button to make adjustments quickly.
6. **Trigger Level.** Adjusts the trigger level.
7. **Run/Stop.** Stops and restarts acquisition.
8. **Single Seq.** Sets acquisition, display, and trigger parameters for a single-shot (single-sequence) acquisition.
9. **Set To 50%.** Sets the trigger level to the midpoint of the waveform.
10. **Autoset.** Automatically sets the vertical, horizontal, and trigger controls for a usable display.
11. **Force Trig.** Forces an immediate trigger event.
12. **Waveform Intensity.** Controls waveform intensity.
13. **B Trig.** Activates the B trigger. Changes the Trigger menu to set the B-trigger parameters.
14. **Delay.** Enables delayed acquisition relative to the trigger event. Use horizontal Position to set the amount of delay.
15. **Horizontal Scale.** Adjusts the horizontal scale factor.
16. **Horizontal Zoom.** Splits the screen and magnifies the current acquisition horizontally.
17. **Waveform Off.** Removes selected waveform from the display.
18. **Vertical Scale.** Adjusts selected waveform vertical scale factor.
19. **1, 2, (3, 4.) Math.** Displays a waveform and chooses the selected waveform. Ref shows the reference waveform menu.

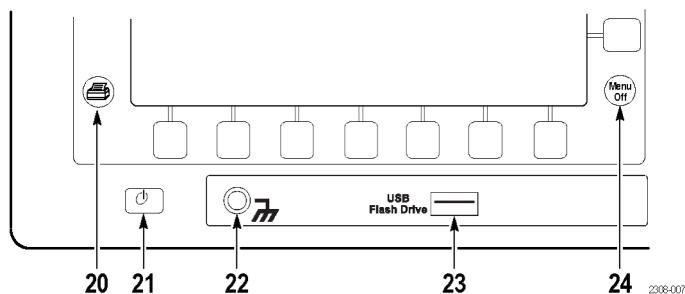

20. Hard copy. Initiates a hard copy using the port selected in the Utility menu.
21. Power switch. Turns power to on or standby. Power-up time varies from about 15 seconds to 45 seconds, depending on the oscilloscope internal calibration process.
22. Wrist-strap ground. Connect a wrist strap when working with ESD-sensitive circuits. This connector is not a safety ground.

NOTE. *The wrist-strap ground terminal is only a ground when the oscilloscope is connected to earth ground. When operating from a battery, connect the grounding wire to earth ground to ensure the terminal is at ground.*

23. USB Flash Drive port.
24. Menu Off. Clears menu from the display.

Identifying Items in the Display

The following items may appear in the display; not all items are visible at any given time. Some readouts move outside the graticule area when menus are turned off.

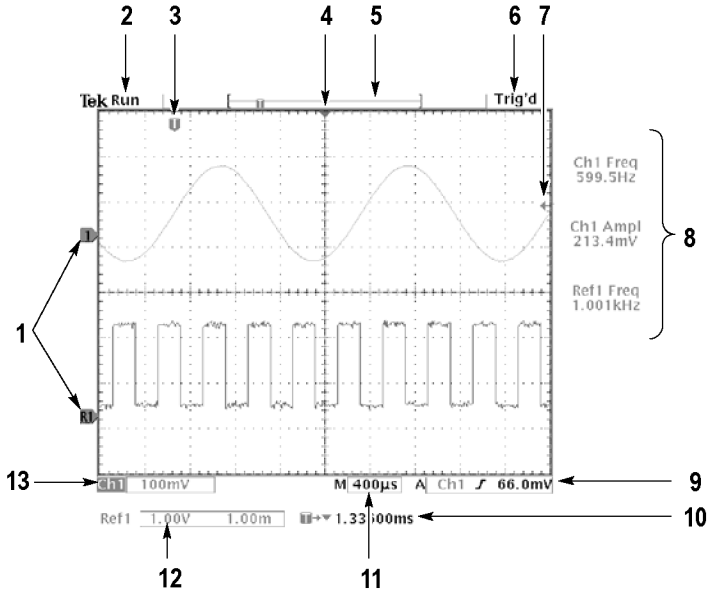

1. Waveform baseline icons show the zero-volt level of the waveforms (ignoring the effect of offset). The icon colors correspond to the waveform colors.
2. Acquisition readout shows when acquisition is running, stopped, or when acquisition preview is in effect.
3. Trigger position icon shows the trigger location in the waveforms.
4. Expansion point icon shows the point that the horizontal scale expands and compresses around.
5. Waveform record icon shows the trigger location relative to the waveform record. The line color corresponds to the selected waveform color.
6. Trigger status readout show trigger status.
7. Trigger level icon shows the trigger level on the waveform. The icon color corresponds to the trigger source channel color.
8. Cursor and measurement readouts show results and messages.

9. Trigger readouts show the trigger sources, slopes, and levels, and position.
10. Readout shows the delay setting or the trigger location within the record.
11. Horizontal readout shows the main or zoom time/division.
12. Auxiliary waveform readouts show the vertical and horizontal scale factors of the math or reference waveforms.
13. Channel readouts show the channel scale factor, coupling, input resistance, bandwidth limit, and invert status.



14. Triangle icon with the battery icon indicates a battery is installed and battery power is in use. The battery icon shows the approximate charge level of the battery. (See page 12, *Operating Safely with Battery Power*.)
15. Power-plug icon with the battery icon indicates a battery is installed but line power is in use. The battery may be charging. The battery icon shows the approximate charge level.

Using QuickMenus

The QuickMenu feature simplifies the use of the oscilloscope. When you push the QuickMenu button, a set of frequently used menu functions show on the display. Then, push the screen buttons around the display to operate the QuickMenu. The Reference chapter has general instructions on how to operate QuickMenus. (See page 100.)

Using the Scope QuickMenu. Scope is one type of QuickMenu that you can use to control the basic oscilloscope functions. You can perform many tasks without using the regular menu system. If you need to use a function that is not contained in the Scope QuickMenu, push the button you would normally push to access that function. For example, if you want to add an automatic measurement, push the Meas button to set up the measurement. Then, push the QuickMenu button to return to the Scope QuickMenu with the measurement also in the display.

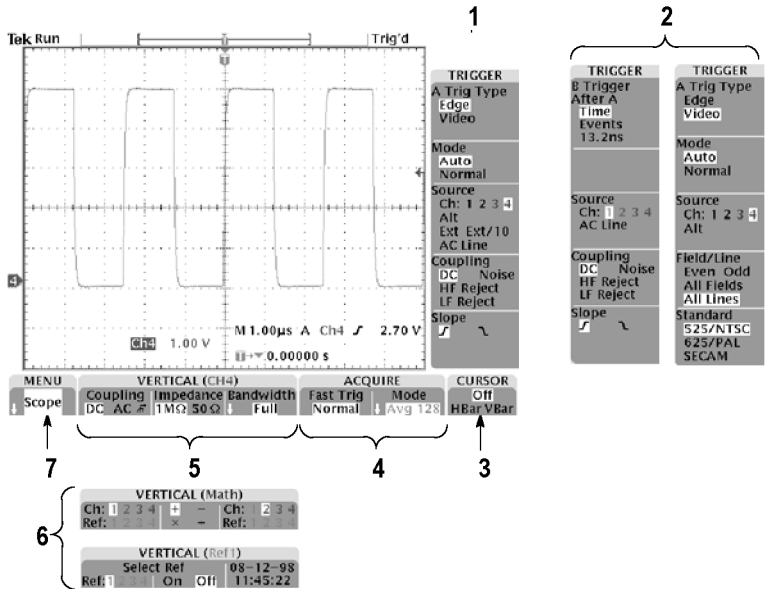

1. Edge Trigger controls. Push these screen buttons to set trigger parameters for edge trigger.
2. Trigger controls if either B trigger or video trigger is selected. Logic and Pulse trigger controls are not available through the QuickMenu.
3. Cursor control. Push this screen button to turn on cursors and select the cursor type. Push the Select button to toggle between the two cursors to select the active cursor. Use the general purpose knob to move the active cursor.
4. Acquisition controls. Push these screen buttons to set acquisition parameters.
5. Channel vertical controls. Push these screen buttons to set vertical controls for the selected channel. Use the channel 1, 2, 3, 4, and the Math and Ref buttons to select the channel you want to control.
6. Vertical controls if either the math waveform or a reference waveform is selected.
7. Menu. Push this screen button to select a specific QuickMenu display if more than one is available.

NOTE. Items in the Scope QuickMenu not mentioned above are also contained in the regular display. (See page 24.)

Other QuickMenus. Some optional application packages include a custom QuickMenu display. Those QuickMenus contain specific features that are important for the application.

Front-Panel Connectors

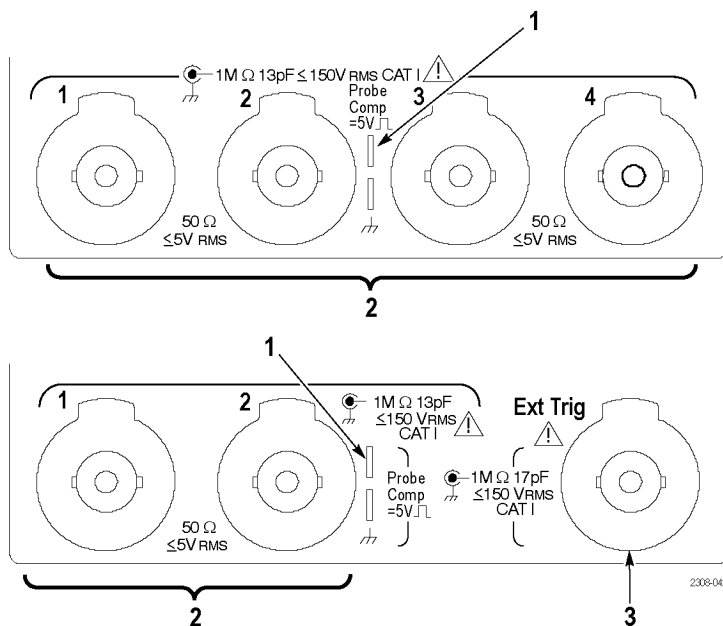

1. Probe Comp. Square wave signal source to compensate probes.
2. 1, 2, (3, 4). Channel inputs with TekProbe interface.
3. Ext Trig. External trigger input with TekProbe interface (two-channel models only). External trigger input specifications are in Appendix A.

Rear-Panel Connectors

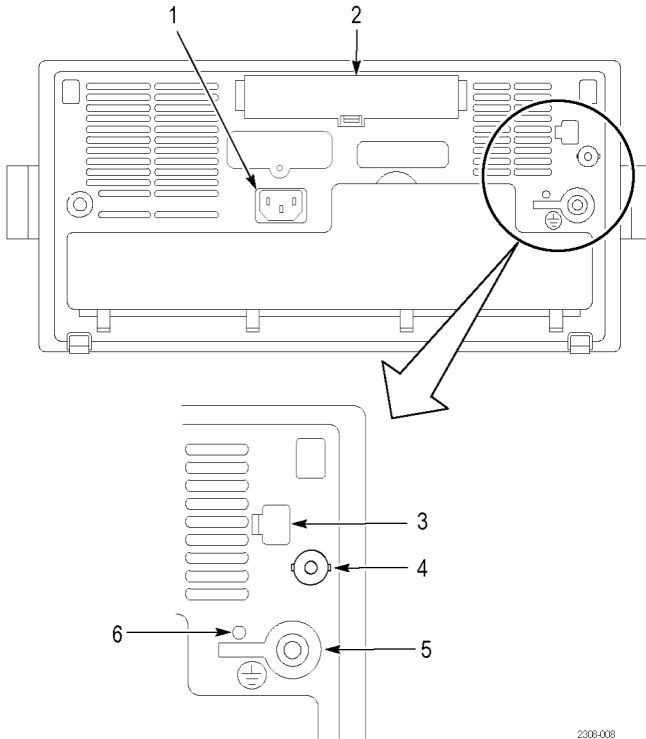

2308-008

1. Power input. Attach to an AC power line with integral safety ground.
2. Communication Module compartment. Install the optional communication module.
3. Ethernet port. Connects the oscilloscope to a 10BaseT local area network.
4. Ext Trig. External trigger input with TekProbe interface (four-channel models only). External trigger input specifications are in Appendix A.
5. Ground terminal. Connect to earth ground when using battery power. (See page 12, *Operating Safely with Battery Power.*)

6. CAL switch. For use by authorized service personnel only.

Communication Module Connectors

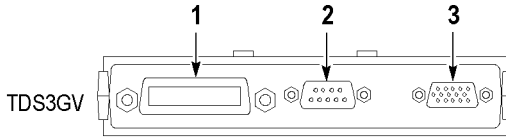

1. GPIB port. Connect to a controller for remote programmability.
2. RS-232 port. Connect to a controller or terminal for remote programmability or printing.
3. VGA port. Connect to a VGA monitor to display the screen image.

Application Examples

This chapter presents six common oscilloscope applications:

- Taking simple measurements
- Analyzing signal detail
- Taking FFT measurements
- Triggering on a video signal
- Capturing a single-shot signal
- Saving data to a USB flash drive

Each application example highlights different features of the oscilloscope and gives you ideas about using the oscilloscope to solve test problems.

Taking Simple Measurements

You need to see a signal in a circuit, but you do not know the signal amplitude or frequency. Connect the oscilloscope to quickly display the signal and then measure its frequency and peak-to-peak amplitude.

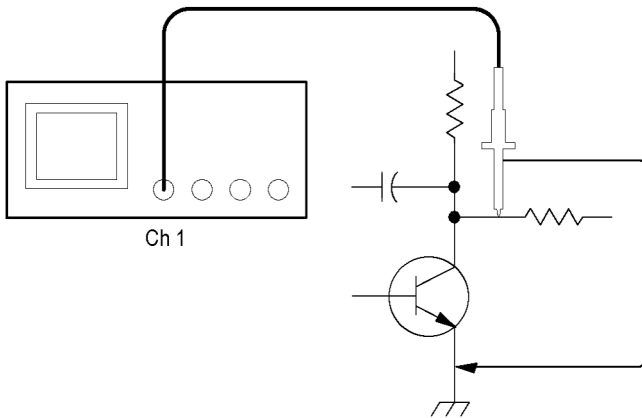

Using Autoset

To quickly display a signal, follow these steps:

1. Connect the channel 1 probe to the signal.
2. Push the **Autoset** button.

The oscilloscope sets vertical, horizontal, and trigger controls automatically. You can manually adjust any of these controls if you need to optimize the display of the waveform.

When you are using more than one channel, the autoset function sets the vertical controls for each channel and uses the lowest-numbered active channel to set the horizontal and trigger controls.

Selecting Automatic Measurements

The oscilloscope can take automatic measurements of most displayed signals. To measure signal frequency and peak-to-peak amplitude, follow these steps:

1. Push the **Meas** button to see the Select Measurement menu.
2. Push the channel **1** button and then push the **Select Measurement for Ch1** screen button.
3. Select the **Frequency** measurement.
4. Push the **more** screen button and select the **Pk-Pk** measurement.
5. Push the **Menu Off** button.

The measurements show on the screen and update as the signal changes.

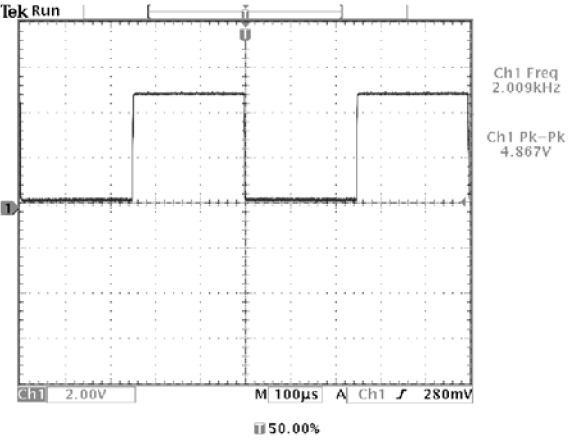

Measuring Two Signals

You are testing a piece of equipment and need to measure the gain of its audio amplifier. You have an audio generator that can inject a test signal at the amplifier input. Connect two oscilloscope channels to the amplifier input and output as shown. Measure both signal levels and use these measurements to calculate the gain.

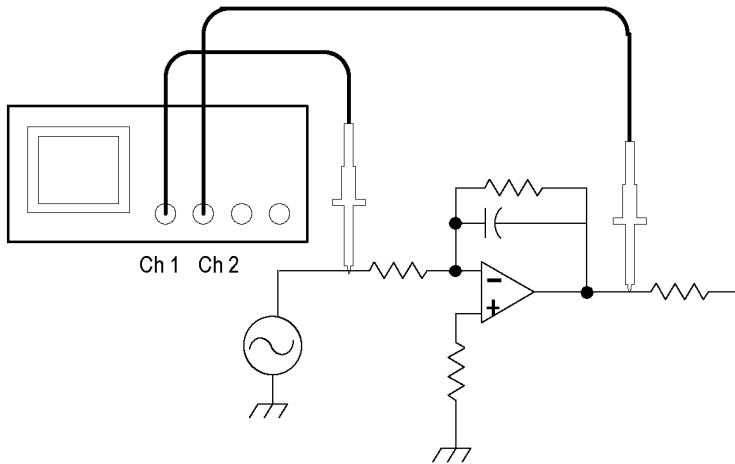

To display the signals connected to channels 1 and 2, follow these steps:

1. Push the channel **1** and **2** buttons to activate both channels.
2. Push the **Autoset** button.

To select measurements for the two channels, follow these steps:

1. Push the **Meas** button to see the Select Measurement menu.
2. Push the channel **1** button and then push the **Select Measurement for Ch1** screen button.
3. Select the **Amplitude** measurement.
4. Push the channel **2** button and then push the **Select Measurement for Ch2** screen button.
5. Select the **Amplitude** measurement.

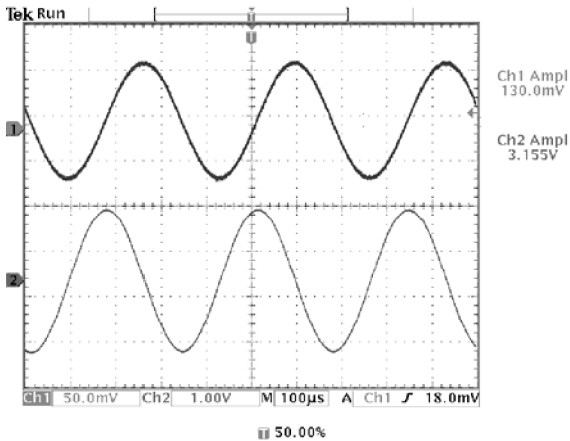

6. Calculate the amplifier gain using the following equations:

$$\text{Gain} = \frac{\text{output amplitude}}{\text{input amplitude}} = \frac{3.155 \text{ V}}{130.0 \text{ mV}} = 24.27$$

$$\text{Gain (dB)} = 20 \times \log(24.27) = 27.7 \text{ dB}$$

2308-009

Customizing Your Measurements

In this example you want to verify that the incoming signal to a piece of digital equipment meets its specifications. Specifically, the transition time from a low logic level (0.8 V) to a high logic level (2.0 V) must be 10 ns or less.

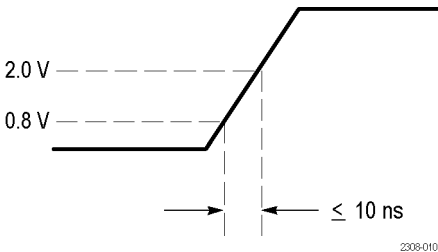

To select the rise time measurement, follow these steps:

1. Push the **Meas** button to see the Select Measurement menu.
2. Push the channel **1** button and then the **Select Measurement for Ch1** screen button.
3. Select the **Rise Time** measurement.

Rise time is typically measured between the 10% and 90% amplitude levels of a signal; these are the default reference levels the oscilloscope uses for rise time measurements. However, in this example you need to measure the time the signal takes to pass between the 0.8 V and 2.0 V levels.

You can customize the rise time measurement to measure the signal transition time between any two reference levels. You can set each of those reference levels to a specific percent of the signal amplitude or to a specific level in vertical units (such as volts or amperes).

Setting Reference Levels. To set the reference levels to specific voltages, follow these steps:

1. Push the **Reference Levels** screen button.
2. Push the **Set Levels in** screen button to select **units**.
3. Push the **High Ref** screen button.
4. Use the general purpose knob to select **2.0 V**.
5. Push the **Low Ref** screen button.
6. Use the general purpose knob to select **800 mV**.

The measurement verifies that the transition time (3.842 ns) meets the specification (≤ 10 ns).

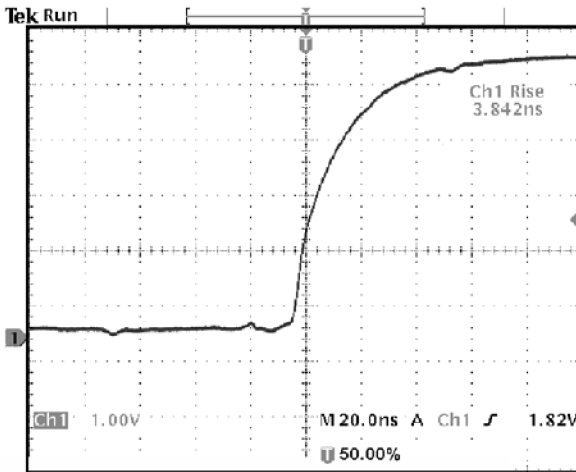

Measuring Specific Events. Next you want to see the pulses in the incoming digital signal, but the pulse widths vary so it is hard to establish a stable trigger. To look at a snapshot of the digital signal, follow this step:

1. Push the **Single Seq** button to capture a single acquisition.

Now you want to measure the width of each displayed pulse. You can use measurement gating to select a specific pulse to measure. To measure the second pulse, for example, follow these steps:

1. Push the **Meas** button.
2. Push the channel **1** button and then push the **Select Measurement for Ch1** screen button.
3. Select the **Positive Pulse Width** measurement.
4. Push the **Gating** screen button.
5. Select **Between V Bar Cursors** to choose measurement gating using cursors.
6. Place one cursor to the left and one cursor to the right of the second pulse.

The oscilloscope shows the width measurement (160 ns) for the second pulse.

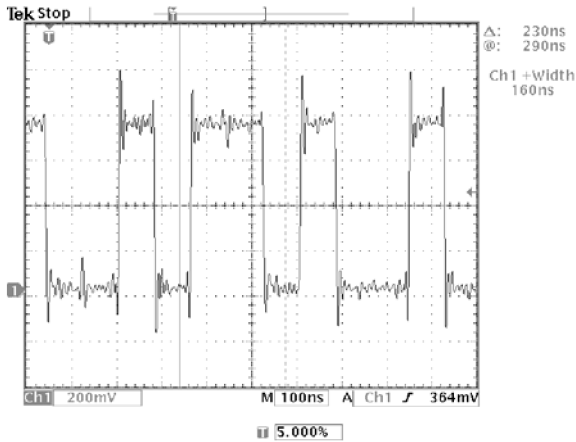

Analyzing Signal Detail

You have a noisy signal displayed on the oscilloscope and you need to know more about it. You suspect that the signal contains much more detail than you can now see in the display.

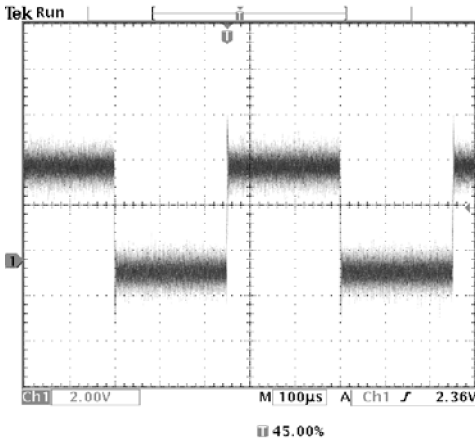

Looking at a Noisy Signal

The signal appears noisy and you suspect that noise is causing problems in your circuit. To better analyze the noise, follow these steps:

1. Push the Acquire **Menu** button.
2. Push the **Mode** bottom button.
3. Select the **Peak Detect** acquisition mode.
4. Increase the **Waveform Intensity** control to see the noise more easily.

Peak detect emphasizes noise spikes and glitches in your signal as narrow as 1 ns, even when the time base is set to a slow setting.

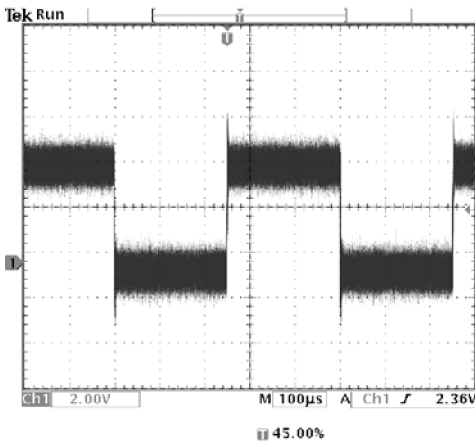

The *Reference* chapter has more information about peak-detect and the other acquisition modes. (See page 65.)

Separating the Signal from Noise

Now you want to analyze the signal shape and ignore the noise. To reduce random noise in the oscilloscope display, follow these steps:

1. Push the Acquire **Menu** button.
2. Push the **Mode** bottom button.
3. Select the **Average** acquisition mode.

Averaging reduces random noise and makes it easier to see detail in a signal. In the next example, a ring shows on the rising and falling edges of the signal when the noise is removed.

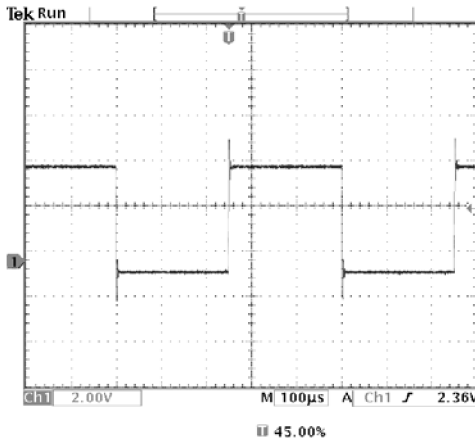

Taking Cursor Measurements

You can use the cursors to take quick measurements on a waveform. To measure the ring frequency at the rising edge of the signal, follow these steps:

1. Push the **Cursor** button.
2. Push the **Function** screen button.
3. Select **V Bars** cursors.
4. Push the **V Bar Units** screen button.
5. Select **1/seconds (Hz)**.
6. Place one cursor on the first peak of the ring using the general purpose knob.
7. Push the **Select** button.
8. Place the other cursor on the next peak of the ring.

The cursor Δ readout shows the measured ring frequency is 227 kHz.

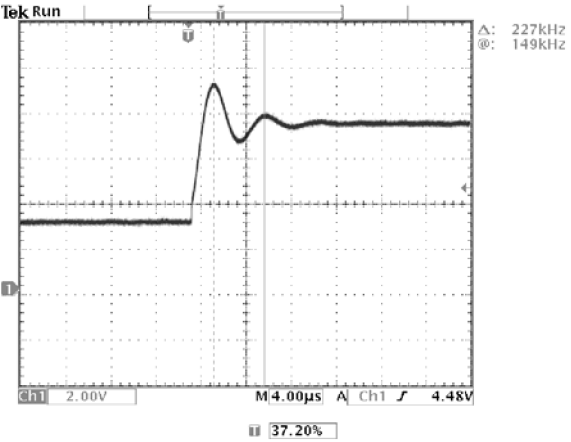

Using Delay

You are analyzing a pulse waveform and use the + Width measurement to measure the waveform pulse width. You notice that the measurement is not stable, which implies that there is jitter in the pulse width.

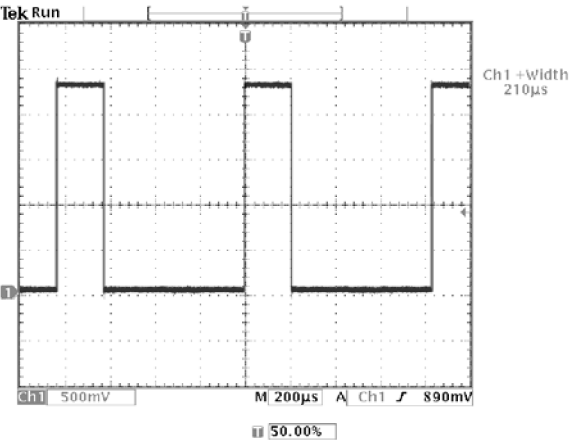

To use delay to see the jitter, follow these steps:

1. Push the **Delay** button.
2. Adjust the horizontal **Position** control to set the delay close to the nominal pulse width (210 μs). Push the **Coarse** button to make delay adjustments more quickly. Push the **Coarse** button again to fine tune the delay time.

The falling edge of the pulse is now near the center of the screen. When delay is on, the horizontal expansion point separates from the trigger point and remains in the center of the screen.

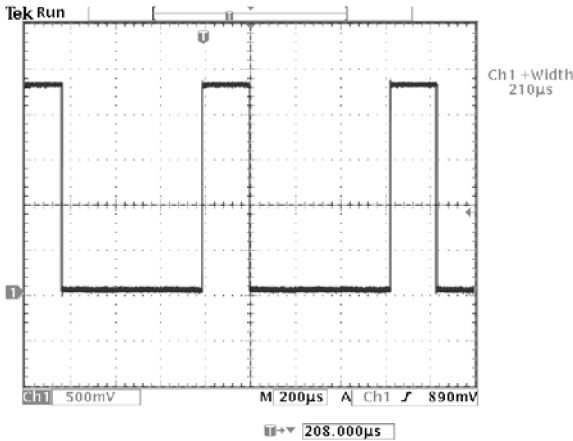

3. Adjust the horizontal **Scale** to a faster time base setting and increase the **Waveform Intensity** to see the jitter in the pulse width.

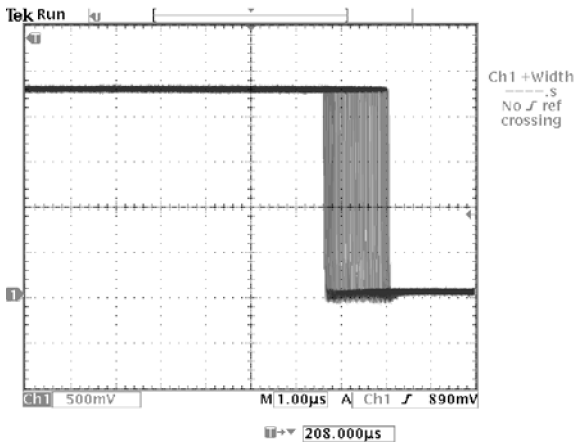

NOTE. You can toggle the delay function on and off to view signal details at two different areas of interest.

Measuring Jitter

To measure the peak-to-peak jitter, follow these steps:

1. Push the **Cursor** button.
2. Push the **Function** screen button.
3. Select the **V Bars** cursors.
4. Push the **Bring Both Cursors On Screen** screen button to quickly locate the cursors.
5. Place one cursor at the first falling edge and place the other cursor at the last falling edge.
6. Read the peak-to-peak jitter in the Δ readout (1.40 μ s).

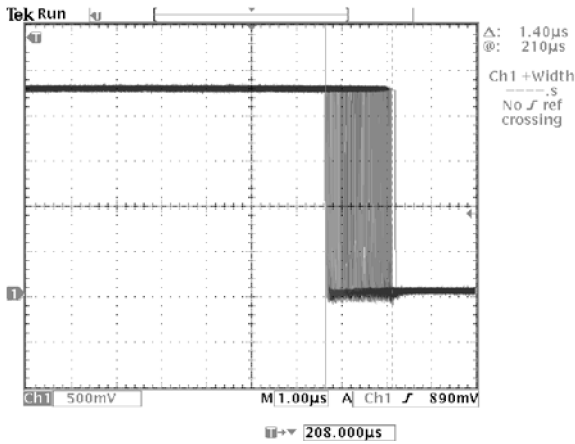

You can also measure the minimum and maximum pulse widths. When you select the first cursor, the @ readout displays the minimum pulse width (210 µs). When you select the second cursor, the @ readout displays the maximum pulse width (211 µs).

Taking FFT Measurements

You can take FFT measurements to determine if low-level distortion is present, or to find the source of noise in a mixed circuit.

Detecting Distortion

A pure sine wave can be input into an amplifier to measure distortion; any amplifier distortion will introduce harmonics in the amplifier output. Viewing the FFT of the output can determine if low-level distortion is present.

You are using a 20 MHz signal as the amplifier test signal. You would set the oscilloscope and FFT parameters as listed in the next table.

Control	Setting
1 Coupling	AC
Acquisition Mode	Average 16
Horizontal Resolution	Normal (10k points)
Horizontal Scale	100 ns
FFT Source	Ch1
FFT Vert Scale	dBV
FFT Window	Blackman-Harris

In the next figure, the first component at 20 MHz (figure label 1) is the source signal fundamental frequency. The FFT waveform also shows a second-order harmonic at 40 MHz (label 2), and a fourth-order harmonic at 80 MHz (label 3). The presence of components 2 and 3 indicate that the system is distorting the signal. The even harmonics suggest a possible difference in signal gain on half of the signal cycle.

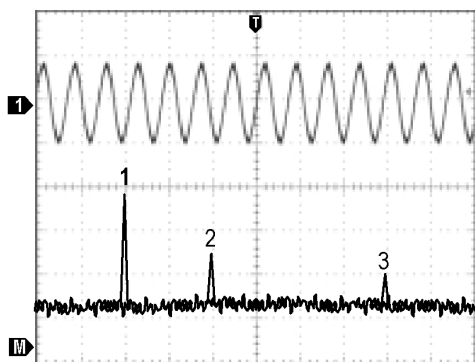

Identifying the Source of Noise

Noise in mixed digital/analog circuits can be easily observed with an oscilloscope. However, identifying the sources of the observed noise can be difficult.

The FFT waveform displays the frequency content of the noise. You may then be able to associate those frequencies with known system frequencies, such as system clocks, oscillators, read/write strobes, display signals, or switching power supplies.

The highest frequency on the example system is 40 MHz. To analyze the example signal, you would set the oscilloscope and FFT parameters as listed in the next table.

Control	Setting
1 Coupling	AC
Acquisition Mode	Sample
Horizontal Resolution	Normal (10k points)
Horizontal Scale	4.00 μ s
Bandwidth	150 MHz
FFT Source	Ch1
FFT Vert Scale	dBV
FFT Window	Hanning

In the next figure, notice the component at 31 MHz (figure label 1). This coincides with a 31 MHz memory strobe signal in the example system. There is also a frequency component at 62 MHz (label 2), which is the second harmonic of the strobe signal.

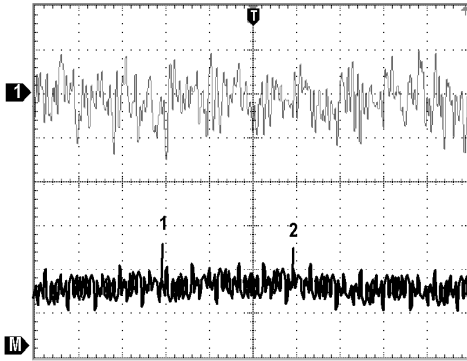

Triggering on a Video Signal

You are testing the video circuit in a piece of medical equipment and need to display the video output signal. The video output is an NTSC standard signal. Use the video trigger to obtain a stable display.

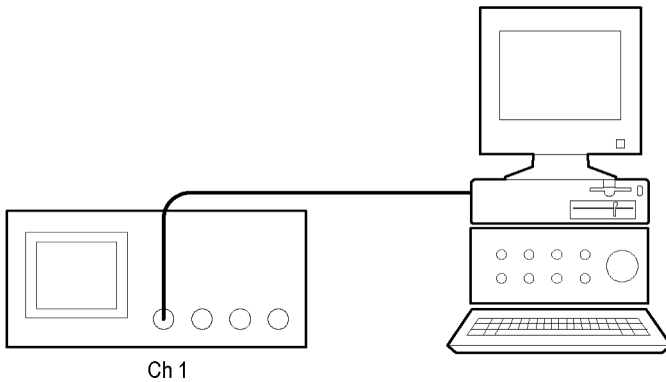

To trigger on the video fields, follow these steps:

1. Push the **Trigger Menu** button.
2. Push the **Type** screen button to select **Video**.
3. Push the **Standard** screen button to select **525/NTSC**.
4. Push the **Trigger On** screen button.
5. Select **Odd**.
6. Adjust the horizontal **Scale** to see a complete field across the screen.
7. Push the **Acquire Menu** button.
8. Push the **Horizontal Resolution** screen button.
9. Select **Normal** acquisition resolution.

Normal acquisition resolution is the best choice to acquire a video field signal because the signal contains a great amount of horizontal detail.

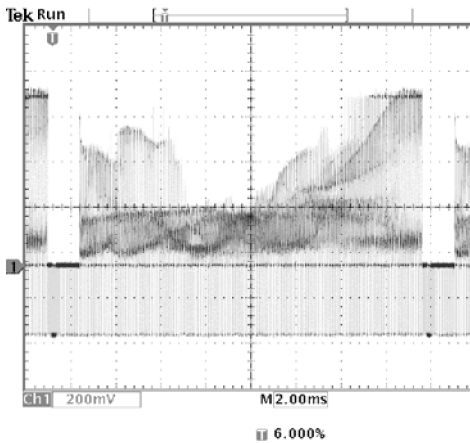

If the signal had been noninterlaced, you could choose to trigger on All Fields.

Triggering on Lines. You can also look at the video lines in the field. To trigger on the lines, follow these steps:

1. Push the **Trigger On** screen button.
2. Select **All Lines**.
3. Adjust the horizontal **Scale** to see a complete video line across the screen.

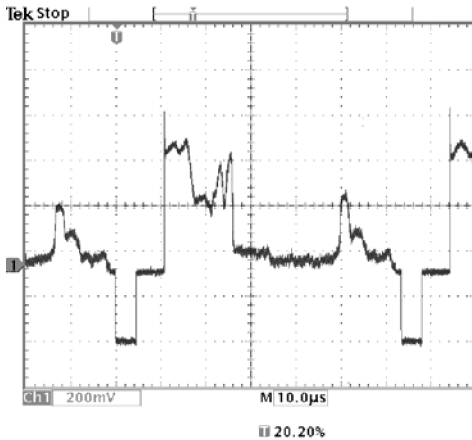

NOTE. The optional TDS3VID and TDS3SDI application modules add new video functions such as a video QuickMenu, video Autoset, trigger on custom scan rates, trigger on specific video lines, vectorscope (vectorscope supports component video only), video picture, trigger on analog HDTV signals, and view 601 digital video signals (TSD3SDI only).

Looking at Modulation. A dedicated video waveform monitor clearly shows the modulation in a video signal. To see a similar modulation display on the oscilloscope screen, follow these steps:

1. Start with triggered display of the video lines.
2. Push the Acquire **Menu** button.
3. Push the **Horizontal Resolution** screen button.
4. Select **Fast Trigger** acquisition resolution.
5. Adjust the **Waveform Intensity** control for the amount of modulation you want to see.

The oscilloscope now shows signal modulation in shades of intensity and appears similar to the display of a video waveform monitor or an analog oscilloscope. Fast trigger acquisition resolution is the best choice to acquire a video line signal with a rapidly changing shape.

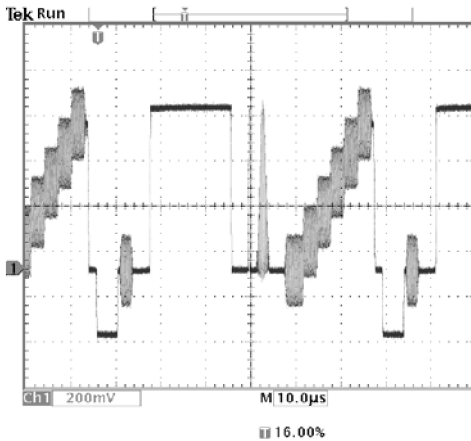

Capturing a Single-Shot Signal

The reliability of a reed relay in a piece of equipment has been poor and you need to investigate the problem. You suspect that the relay contacts arc when the relay opens. The fastest you can open and close the relay is about once per minute so you need to capture the voltage across the relay as a single-shot acquisition.

To set up for a single-shot acquisition, follow these steps:

1. Adjust the vertical **Scale** and horizontal **Scale** to appropriate ranges for the signal you expect to see.
2. Push the Acquire **Menu** button.
3. Push the **Horizontal Resolution** screen button.
4. Select **Normal** acquisition resolution.
5. Push the **Single Seq** (single sequence) button.

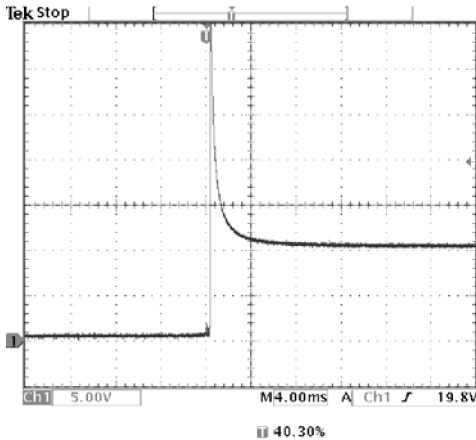

The Single Seq button sets trigger parameters to the correct settings for a single-shot acquisition.

Optimizing the Acquisition

The initial acquisition shows the relay contact beginning to open at the trigger point. This is followed by a large spikes that indicate contact bounce and inductance in the circuit. The inductance can cause contact arcing and premature relay failure.

Before you take the next acquisition, you can adjust the vertical and horizontal controls to give you a preview of how the next acquisition might appear. As you adjust these controls, the current acquisition is repositioned, expanded, or compressed. This preview is useful to optimize the settings before the next single-shot event is captured.

When the next acquisition is captured with the new vertical and horizontal settings, you can see more detail about the relay contact opening. You can now see that the contact bounces several times as it opens.

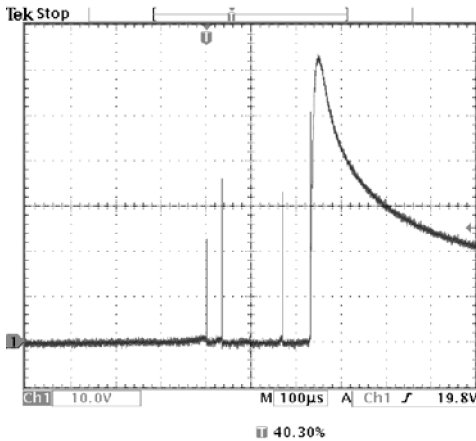

Using the Horizontal Zoom Function

If you want to take a close look at a particular spot on the acquired waveform, use the horizontal zoom function. To look closely at the point where the relay contact first begins to open, follow these steps:

1. Push the zoom button .
2. Use the horizontal **Position** to place the expansion point close to where the relay contact begins to open.
3. Adjust the horizontal **Scale** to magnify the waveform around the expansion point.

The ragged waveform and the inductive load in the circuit suggest that the relay contact may be arcing as it opens.

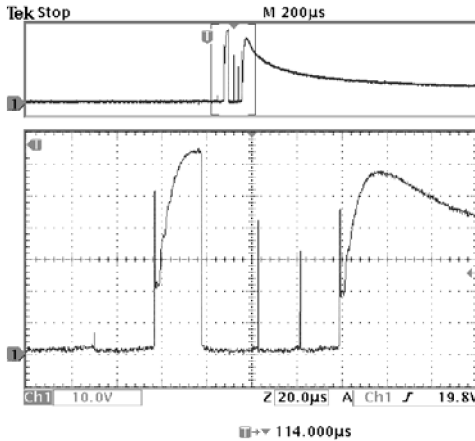

The zoom function works equally well when acquisition is running or is stopped. Horizontal position and scale changes affect only the display, not the next acquisition.

Saving Data to a USB Flash Drive

You need to do some work inside a remote site. You expect to use the oscilloscope to look at signal waveforms, to bring the waveform information back to the office to complete a report, and to perform additional analysis. To do this, take along a USB flash drive.

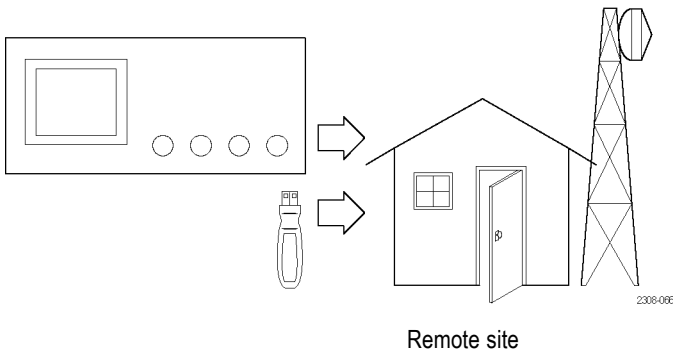

When you need to capture screen images, it may be most convenient to first save them to a USB flash drive. Once on the USB flash drive, you can load the screen images into a PC, print hard copies with a printer attached to your PC, or import the screen images into desktop publishing software to produce a report.

Similarly, you can also save waveform data on the USB flash drive. From the flash drive, you can recall waveforms to the oscilloscope display or you can import the data into spreadsheet and Mathcad software to perform additional analysis.

If you have oscilloscope setups that you want to use again, you also can store them on the USB flash drive. The Reference chapter has more information on this capability. (See page 101, *Save/Recall*.) For information about remote control accessories, see *Appendix C: Accessories*.

Saving Screen Images

While working at the remote site you discover a control signal that you want to capture periodically to show its long-term variation. You want to include these waveforms in a report you are preparing back at the office.

Your desktop publishing software can import BMP graphics, so you decide to use this format for the screen images. To setup this configuration, follow these steps:

1. Insert a USB flash drive into the USB flash drive port.
2. Push the **Utility** button.
3. Push the **System** bottom button to select **Hard Copy**.
4. Push the **Format** screen button.
5. Select **BMP Mono Windows mono image file format** (you may need to push the **- more -** screen button several times before you see this choice).
6. Push the **Port** screen button.
7. Select **File** to send hard copies to a USB flash drive.
8. Push the hard copy button  to save the image.

The oscilloscope reads the flash drive directory and displays its contents.

Naming Files. You should give files descriptive names so you can recognize them when you get back to the office. You will be saving images of the control signal so you decide if CNTRL is a logical target file name to use.

The oscilloscope can append an automatic sequence number to the target file name. This feature is convenient because you want to capture a screen image of the same control signal every five minutes. To set up the target file name and automatic sequence, follow these steps:

1. Push the **File Utilities** bottom button.
2. Use the general purpose knob to highlight the file **TEK?????.BMP**.
3. Select the **Rename** screen button.
4. Use the screen buttons to clear the existing file name and enter the new file name **CNTRL???.BMP**. The question marks are placeholders for an automatic number sequence from 000 to 999.
5. Push the **OK Accept** screen button to setup the target base file name.
6. Push **Menu Off** to remove the file list from the display.

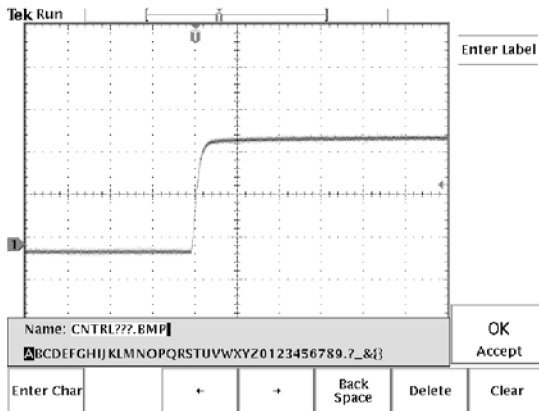

Running the Test. To capture the control signal every few minutes, follow these steps:

1. Display the signal, measurements, and menus as you want them to appear in the screen images.
2. Push the hard copy button .
3. Repeat step 2 every few minutes until you are finished with the test.
4. When you are finished, push **Utility** to see the list of sequential files that have been saved.

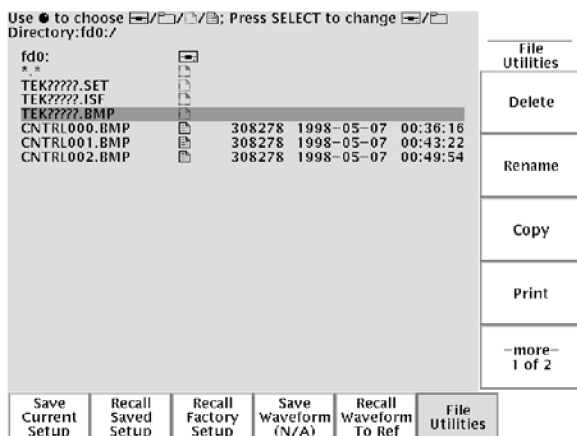

The files are labeled with their sequential names, as well as the time and date each was created.

Saving Waveform Data

You find another signal that you want to analyze with a spreadsheet program back at the office. To save the waveform data on a USB flash drive, follow these steps:

1. Display the signal on the oscilloscope screen.
2. Push the **Save/Recall** button.
3. Push the **Save Waveform** screen button.
4. Select **To File**.
5. Select **Spreadsheet File Format**. The default target file, TEK?????.CSV, is now automatically highlighted.
6. Push the **Save To Selected File** screen button to save the waveform.
7. Push the **File Utilities** screen button to see the saved waveform file TEK00000.CSV in the USB flash drive directory.

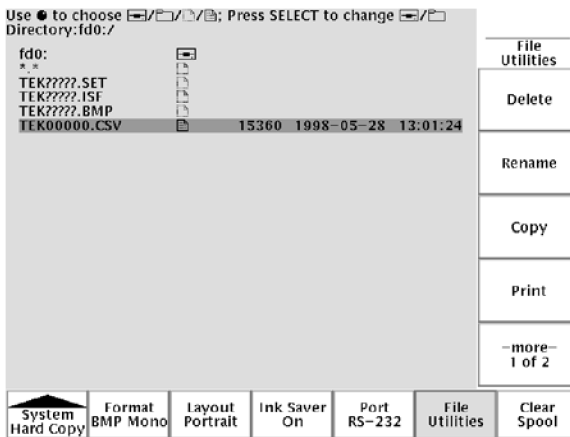

Reference

This chapter contains detailed information about the operation of the oscilloscope. The topics in this chapter are arranged by front-panel button or control group name.

Acquisition Controls



Run/Stop Button

**Run/
Stop**

Push the Run/Stop button to stop and start waveform acquisition. You can also push Run/Stop when you want to resume continuous acquisition after a single-sequence acquisition. A readout in the top left corner of the display shows the status of the acquisition.

Acquisition status readout	Description
Run:	The acquisition is running.
Roll:	A roll-mode acquisition is running.
Stop:	The acquisition is stopped.
PreVu:	Previewing; waiting for trigger.

While the acquisition is running or stopped, you can use these controls to examine the waveforms:

- Channel buttons to select a channel
- Zoom button  with horizontal Position and Scale to magnify waveforms (does not affect the actual time base or trigger position settings)
- Waveform Intensity to adjust gray-scale level
- Cursor button to activate cursors to measure waveforms
- Meas button to select automatic measurements of waveforms
- Hard copy button  to print a hard copy

While the acquisition is stopped, you can change the vertical and horizontal controls to use in the next acquisition. (See page 63, *Vertical and Horizontal Preview*.)

Single Sequence Button

Single Seq

Push the Single Seq button to execute a single-shot acquisition. The function of the Single Seq button depends on the acquisition mode.

Acquisition mode	Single Seq function
Sample or Peak Detect	One acquisition of each displayed channel is acquired, concurrently
Envelope N or Average N	N acquisitions of each displayed channel are acquired (N is adjustable with the general purpose knob)

When you push the Single Seq button, the oscilloscope does the following things:

- At sweep speeds of 20 ms/div and faster, the trigger mode is set to Normal
- The trigger system arms and an LED lights next to the Single Seq button

After the single-sequence acquisition is complete, the acquisition stops and the light next to the Single Seq button turns off.

Push the Single Seq button again to acquire a new sequence, or push the Run/Stop button to restart continuous acquisition.

Autoset Button

Autoset

Push the Autoset button to automatically adjust the vertical, horizontal, and trigger controls for a usable display. You can manually adjust any of these controls if you need to optimize the display.

When you use more than one channel, the autoset function sets the vertical scale for each channel and positions the channels to prevent overlapping. The autoset function selects the lowest-numbered channel in use and then uses that channel to set the horizontal and trigger controls.

The autoset function also changes the following oscilloscope settings:

- Acquisition mode is set to Sample
- Bandwidth limits are set to Full
- Zoom is turned off
- Trigger is set to Auto mode and minimum holdoff
- Trigger is set to Edge type, DC coupling, and rising slope
- B trigger is turned off
- XY display format is turned off
- Channel 1 is turned on and selected if no active channels are in use

If you push the Autoset button by accident, you can undo it with these steps:

1. Push the Acquire **Menu** button.
2. Push the **Autoset** screen button and then push the **Undo Autoset** screen button.

Waveform Intensity



The Waveform Intensity knob adjusts the intensity of the waveforms in the display.

The term Digital Phosphor represents the way this control simulates the intensity control of an analog oscilloscope. At maximum intensity, all waveform points are displayed at full brightness. As you decrease the intensity, you can see intensity grading in the waveforms. The brightest parts of the waveform are the points most frequently acquired; the dimmer parts represent less frequently acquired points. All points decay in intensity over time unless the display persistence is set to infinite.

Use a medium intensity setting to get an analog-oscilloscope view of time-varying signals and those containing modulation. Use the maximum intensity setting to view the signals the way most digital oscilloscopes display them.

You can turn on display persistence to slow or prevent the decay of the waveform points. With persistence on, you can simulate the function of an analog storage oscilloscope. (See page 75, *Display*.)

NOTE. *The waveform intensity may change when you change oscilloscope acquisition modes or horizontal scale settings. Use the INTENSITY knob to readjust waveform intensity.*

Acquire Menu

Menu

Push the Acquire Menu button to show the Acquire menu.

Bottom	Side	Description
Mode	Sample	Use for normal acquisition.
	Peak Detect	Detects glitches and reduces the possibility of aliasing.
	Envelope N	Captures variations of a signal over a period of time. (Adjust N with the general purpose knob.)
	Average N	Reduces random or uncorrelated noise in the signal display. (Adjust N with the general purpose knob.)
Horizontal Resolution	Fast Trigger (500 points)	Acquires 500 point waveforms at a fast repetition rate.
	Normal (10k points)	Acquires 10,000 point waveforms with more horizontal detail.
Reset Horizontal Delay	Set to 0 s	Resets the horizontal delay time to zero.
Autoset	Normal Autoset	Executes the autoset function. (Optional application modules may add choices to execute specialized autoset functions.)
	Undo Autoset	Reverts to the settings before the last autoset.

Bottom	Side	Description
WaveAlert	Wfm Anomaly Detection On Off	Enables or disables the WaveAlert function. (See page 68, <i>WaveAlert Waveform Anomaly Detection</i> .)
	Sensitivity nn.n%	Sets the WaveAlert sensitivity. Use the general purpose knob to set sensitivity from 0% (least sensitive) to 100% (most sensitive).
	Beep On Anomaly On Off	When On, the oscilloscope beeps when it detects a waveform anomaly on any active channel.
	Stop On Anomaly On Off	When On, the oscilloscope stops waveform acquisition when there is a waveform anomaly on any channel. The input waveforms and anomalies remain displayed on the screen.
	Hard Copy On Anomaly On Off	When On, the oscilloscope sends an image of the screen to the hard copy device or USB flash drive file when there is a waveform anomaly on any channel.
	Wfms To Disk On Anomaly On Off	When On, the oscilloscope saves the anomalous waveform(s) data to a file on a USB flash drive.
	Highlight Entire Wfm	Highlights the entire anomalous waveform.
	Highlight Anomalies	Highlights just the anomalous data in a waveform.

Key Points

Vertical and Horizontal Preview. The vertical and horizontal preview functions let you change the vertical and horizontal controls while the acquisition is stopped or while it is waiting for the next trigger. The oscilloscope rescales and repositions the current acquisition in response to the new control settings, and then uses the new settings for the next acquisition.

Preview helps you optimize these control settings before the next acquisition; this makes it easier to work with signals that are single-shot or have a low repetition rate. (See page 141, *Vertical Preview*.) (See page 85, *Horizontal Zoom and Preview*.)

While the acquisition is stopped you can make changes to other controls, but those changes will only take affect with the next acquisition. There is no preview for control changes other than the vertical and horizontal controls.

The preview functions also do not affect automatic measurements, cursor measurements, or the Math waveform. This data for these functions is always based on the current acquisition. If you rescale or reposition a channel waveform horizontally, it may not appear time-correlated to the automatic measurements, cursor measurements, or the Math waveform.

Acquisition Modes. You can choose one of four acquisition modes: Sample, Peak Detect, Envelope, or Average. The next few pages describe these acquisition modes in detail.

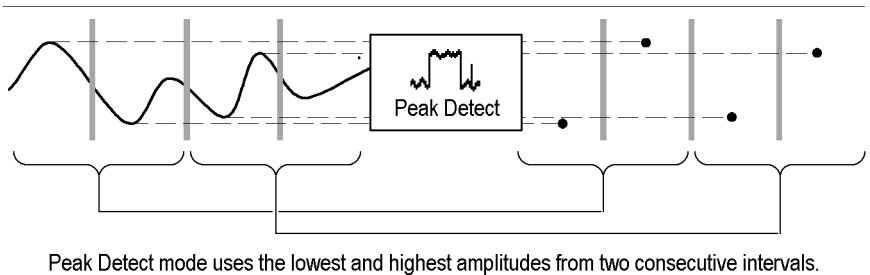
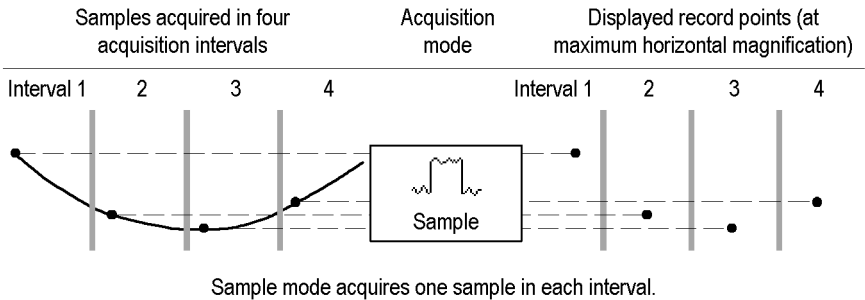

Sample. Use Sample acquisition mode for the fastest acquisition at any SEC/DIV setting. Sample mode is the default mode.

Peak Detect. Use Peak Detect acquisition mode to limit the possibility of aliasing. Also, use Peak Detect for glitch detection. You can see glitches as narrow as 1 ns.

Peak Detect is only functional for sample rates up to 125 MS/s. For 250 MS/s and faster sample rates, the oscilloscope reverts to Sample acquisition mode, where the narrowest detectable pulse width is $1/(\text{sample rate})$.

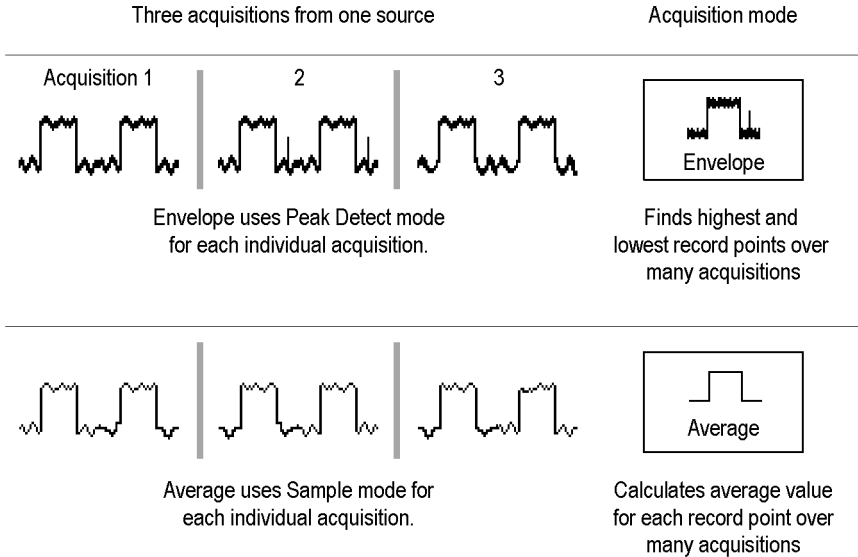

Envelope. Use Envelope acquisition mode to capture the minimum and maximum extremes of a signal over a specified number of acquisitions (N). The enveloped waveform data acquisition clears and then starts over after each N acquisitions. If you push the Single Seq button, envelope acquisition stops after N acquisitions. Use the general purpose knob to set the number of acquisitions.

Average. Use Average acquisition mode to reduce random or uncorrelated noise in the signal you want to display. The averaged waveform is a running average over a specified number of acquisitions (N). If you push the Single Seq button, average acquisition stops after N acquisitions. Use the general purpose knob to set the number of acquisitions.

If you probe a noisy square wave signal that contains intermittent, narrow glitches, the waveform displayed will vary depending on the acquisition mode you choose.

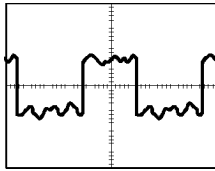

Sample

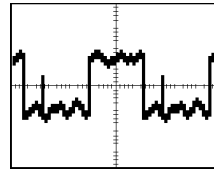

Peak Detect

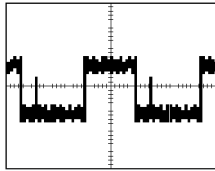

Envelope

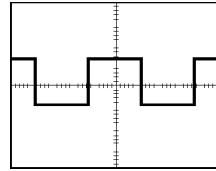

Average

Acquisition Resolution. You can choose either Normal or Fast Trigger acquisition resolution. This setting determines the record length that is acquired and affects the other factors shown in the next table.

Factor	Normal	Fast trigger
Record length	10,000 points	500 points
Maximum acquisition rate	700 waveforms/s	3,400 waveforms/s
Maximum horizontal zoom	200X	10X

Choose Normal or Fast Trigger acquisition resolution based on the characteristics of the signal you want to acquire.

Signal characteristic	Better choice
Large amount of horizontal detail	Normal
Shape is stable or changes relatively slowly	
Single shot	
High trigger repetition rate	Fast Trigger
Shape changes rapidly	
Contains modulation	

WaveAlert Waveform Anomaly Detection. WaveAlert provides a way to detect when a waveform deviates from a steady-state condition. WaveAlert monitors the current waveform acquisition and compares it to the previous DPO waveform acquisitions, using a sensitivity value to adjust the comparison tolerance. If the current acquisition exceeds the comparison tolerance, the oscilloscope considers the current acquisition as an anomaly.

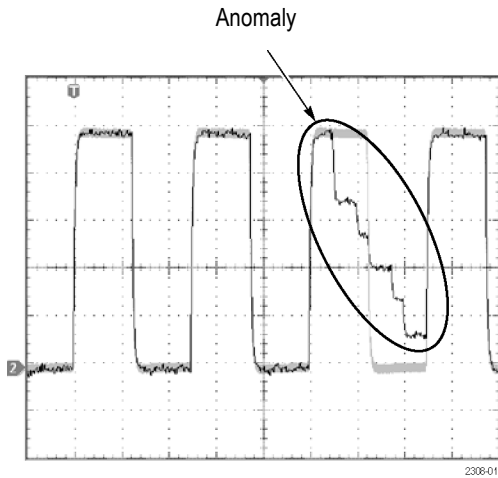

The oscilloscope can respond to an anomalous waveform by stopping acquisitions, emitting a beep, saving the anomalous waveform to a USB flash drive file, printing the screen image to a hard copy device, or any combination of the above. You can also select to highlight just the anomalous data in a waveform, or the entire anomalous waveform.

To use WaveAlert, follow these steps:

1. Display the waveform or waveforms on the screen.
2. Push the Acquire **Menu** front-panel button.
3. Push the **WaveAlert** bottom button.
4. Push the **Wfm Anomaly Detection** side button to select **On**.
5. Push - **more - 1 of 2** and then the **Highlight Anomalies** side button to select **On**.
6. Push - **more - 2 of 2** and then the **Sensitivity** side button.
7. Use the general purpose knob to set the comparison sensitivity value. As signal noise and intensity levels affect the displayed waveform, you will need to experiment with the sensitivity setting to reduce the number of false anomalies due to signal noise.
8. Use the **Waveform Intensity** front-panel button to adjust the persistence of the anomaly waveform.
9. Once you have set the sensitivity value to reduce or eliminate false anomalies, push one or more side menu buttons to select the actions to perform when the oscilloscope detects an anomaly.
10. To restart WaveAlert while in **Stop On Anomaly**, push the Acquire **Run/Stop** front panel button.

WaveAlert Key Points.

- You can use WaveAlert to monitor up to four waveforms or DPO Math waveforms. However, adjacent waveforms can not touch or overlap on the screen.
- To increase your chances of capturing an anomaly by acquiring the maximum number of waveforms per second, set **Acquire > Horizontal Resolution** to **Fast Trigger** (500 points).
- When WaveAlert is on, the front-panel **Waveform Intensity** knob controls the persistence of the anomalous waveform instead of waveform intensity.
- To capture a very random event (minutes to hours), enable the **Wfms To Disk On Anomaly** function to write anomalous waveform data to a USB flash drive file in .isf format. The number of files you can save depends on the waveform record length. You can determine when the anomaly occurred by checking the file create date and time.
- You can use WaveAlert on DPO math waveforms.
- Changing the vertical or horizontal oscilloscope settings does not affect the sensitivity setting. The sensitivity is calculated from the new waveform data after changing the oscilloscope settings.

Cursor

Cursors are on-screen markers that you position to take waveform measurements. There are two cursor types: YT cursors and XY cursors. (See page 74, *XY Cursor Menu*.)

YT Cursor Menu

Cursor

The following YT cursor menu items are available while you are in YT display mode (**Display > XY Display > Off (YT)**). Push the Cursor button to show the cursor menu.

Bottom	Side	Description
Function	Off	Turns cursors off.
	H Bars	Use to make vertical measurements.
	V Bars	Use to make both vertical and horizontal measurements.
	Bring Selected Cursor to Center Screen	Moves the active cursor to center screen.
	Bring Both Cursors On Screen	Moves any off-screen cursor onto the screen.
Mode	Independent	Sets cursors to move independently.
	Tracking	Sets cursors to move together when cursor 1 is selected.
V Bar Units	Sec (s) / 1/sec (Hz)	Sets horizontal units to seconds or frequency (Hz).
	Ratio (%)	Sets V Bar measurement units to percent.
	Phase (°)	Sets V Bar measurement units to degrees.
	Use Cursor Positions as %/°	Sets the V Bar measurement scale so that 0% or 0° is the current position of the left V Bar cursor and 100% or 360° is the current position of the right V Bar cursor.
	Use 5 divs as %/°	Sets the V Bar measurement scale so that 5 screen major divisions is 100% or 360°, where 0% or 0° is -2.5 divisions and 100% or 360° is +2.5 divisions from center vertical graticule.

Bottom	Side	Description
H Bar Units	Base	Sets the H Bar units to be the same as the selected waveform's vertical measurement units (volts, IRE, dB, and so on).
	Ratio (%)	Sets H Bar units to percent.
	Use Cursor Positions as 100%	Sets the H Bar measurement scale so that 0% is the current position of the lowest H Bar cursor and 100% is the current position of the highest H Bar cursor.
	Use 5 divs as 100%	Sets H Bar measurement scale so that 5 screen major divisions is 100%, where 0% is -2.5 divisions and 100% is +2.5 divisions from the center horizontal graticule.

Key Points

Cursor Movement. Use the general purpose knob to move the active cursor. Push the Select button to change which cursor is active. The active cursor is the solid line.

Faster Cursor Movement. Push the Coarse button to set the general purpose knob to make faster cursor movement.

Finding Cursors. When using zoom, delay, or the fastest time base settings, the cursors can go off screen. If you want to find them, use the Bring Both Cursors On Screen function to move them onto the screen.

Fine Cursor Movement. When you magnify the waveform with the zoom function, you can easily set the cursor to any point on the waveform.

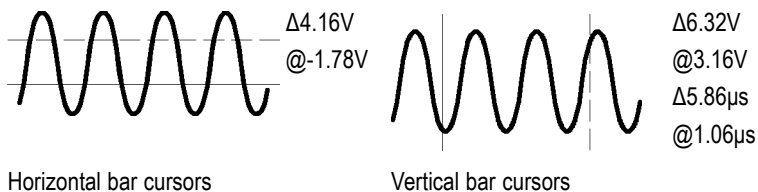

Δ Readout. The Δ readouts indicate the difference between the cursor positions.

@ Readout. For H Bar or V Bar cursors, the voltage readout after the @ symbol indicates the location of the active cursor relative to zero volts. For V Bar cursors, the time readout after the @ symbol indicates the location of the active cursor relative to the trigger point.

Cursor Interaction with Preview. If you change a vertical or horizontal control setting while acquisition is stopped or it is waiting for trigger, the cursors move with the waveforms and cursor measurements remain valid.

Taking Gray-Scale Measurements. Using cursors is often the best way to take simple measurements on waveforms that contain significant gray-scale information. The automatic measurements operate only on the latest acquisition, not on the previous acquisitions that are displayed in gray scale. However, you can set the cursors to surround and measure the gray-scale area of the waveform.

Cursors at Same Position. If both cursors are at the same position, and H Bars or V Bars are set to Ratio or Phase, both cursors are set to 0% (or 0°). 100%/360° is set to one pixel width away from the cursor position.

V Bars and FFT. When the selected waveform is an FFT waveform, selecting V Bars and Phase sets the measurement to percent.

Tracking Mode. In cursor tracking mode, both cursors move together when cursor 1 is selected. Enabling tracking mode automatically selects cursor 1 as the active cursor. If cursor 2 is selected while in tracking mode, only cursor 2 will move.

XY Cursor Menu

Cursor

The following XY cursor menu items are available while you are in XY display mode (**Display > XY Display > Triggered XY**). Push the Cursor button to show the cursor menu.

Bottom	Side	Description
Function	Off	Turns cursors off.
	Waveform	Turns waveform cursors on and displays measurements in rectangular format (X and Y values). Use the front-panel Select button to select which cursor to move (the active cursor). Use the general purpose knob to move the active cursor.
Mode	Independent	Sets cursors to move independently.
	Tracking	Sets cursors to move together when the reference cursor is selected.

NOTE. The Advanced Analysis application module (TDS3AAM) adds more XY cursor features, including graticule cursors and polar readouts.

Key Points

XY Waveform Cursors. To turn off the XY waveform cursor measurement, push the front panel **Cursor** button, then push the Cursor Function **Off** side menu button.

Measurements. The XY waveform cursor measurements show difference (Δ) and absolute (@) values for the X axis, the Y axis, and the time of the active cursor.

ΔX : 1.43V @X: -140mV
 ΔY : 2.14V @Y: 480mV
 Δt : -660ns @t: 1.61ms

There are two waveform cursors; a reference cursor \boxplus , and a delta cursor \oplus . All difference (Δ) measurements are measured from the reference cursor to the delta cursor. A negative ΔX measurement means that the delta cursor is positioned earlier in the waveform record than

the reference cursor. A negative ΔY measurement means that the delta cursor is positioned at a lower Y waveform signal level than the reference cursor.

All absolute (@) measurements are referenced to the XY waveform's 0, 0 origin, and show the value of the active cursor.

0, 0 Origin. The XY waveform origin is the 0 volt point of each source waveform. Positioning both source waveform 0 volt points on the vertical center graticule places the origin in the center of the screen.

Switching Between XY and YT. You can switch between XY and YT display mode to see the location of the cursors in the YT waveform. The waveform record icon at the top of the graticule also shows the relative cursor positions in the waveform record.

Waveform Sources. You can use XY cursors on active acquisitions, single sequence acquisitions, and reference waveforms. You need to store both XY source waveforms in order to recreate an XY waveform. The X axis waveform must be stored in Ref1.

Display

Display

Push the Display button to show the display menu.

Bottom	Side	Description
Waveform Display	Dots Only	Set to on to see dots only. Set to off to see dots and vectors.
	Persist Time	Sets persist time.
	Set to Auto	Sets the Waveform Intensity knob to control the persistence time.
	Clear Persistence	Clears any displayed persistence.
Backlight Intensity	High	Use for bright ambient conditions.
	Medium	Use for dim ambient conditions.
	Low	Use to extend battery-operation time.

Bottom	Side	Description
Graticule	Full, Grid, Cross Hair, Frame	Sets the graticule type.
XY Display	Off (YT)	Turns off an XY display.
	Triggered XY	Turns on triggered XY display.
	Gated XYZ	Turns on gated XY display. Displays XY signals when Z-channel signal is above a set level. Only available on 4-channel instruments.
	Ch1 (X) Versus	Sets Ch2, Ch3, or Ch4 as the Y channel versus Ch1 as X.
	Ref1 (X) Versus Gated By	Sets Ref2, Ref3, or Ref4 as the Y channel versus Ref1 as X. Sets Ch2, Ch3, or Ch4 as the Z-channel gate source, and sets the gating channel threshold level.
Color Palette	Normal	Selects the color display.
	Monochrome	Sets all waveforms to high-contrast black and white.

Key Points

Waveform Dots and Vectors. With Dots Only set to off, the vectors between samples can be filled; increase the Waveform Intensity control to increase the amount of vector fill between samples. The vector fill is most visible on fast signal edges or when the horizontal zoom  is turned on.

Turn Dots Only on if you want to see just the actual samples.

Waveform Persistence. Turn on waveform persistence to slow the decay of waveform points. You can set the persistence to a specific time or to infinite. Infinite persistence keeps all waveform points in the display until you change a control setting that erases the display.

Display Colors. The channel buttons, waveforms, icons, and readouts are color-coded to help you identify them easily. The colors are preset and cannot be adjusted. However, you can select the Monochrome

Color Palette if you prefer to see all the waveforms in high-contrast black and white.

XY Waveform Triggering. The XY waveform is triggered so you can synchronize periodic input signals to the XY waveform. This feature is useful when only one part of the period contains valid information that you want to see in the XY format. Set the time base and trigger location to acquire just that part of the period.

When you want to see the complete period of the signals regardless of the time base setting, set the trigger source to an unused channel and the trigger mode to Auto.

XY Waveform Scale and Position. If you want to display channel 1 in the horizontal axis versus channel 3 in the vertical axis, for example, use these controls to scale and position the XY waveform:

- Push the channel 1 button and use the vertical Scale and Position controls to set the horizontal scale and position of the XY waveform.
- Push the channel 3 button and use the vertical Scale and Position controls to set the vertical scale and position of the XY waveform.

XY Waveform Restrictions. The math waveform, zoom, and autoset functions do not work in the XY display format. All reference waveforms displayed in XY format must have the same record length, 500 or 10,000 points.

Gated XYZ. Displays XY signals only when the Z (gating) channel is true. Gated XYZ is similar to analog oscilloscope modulated XYZ mode except that the displayed XY signal is either on or off; there is no intensity modulation. Gated XYZ is useful for showing constellation diagrams.

Push the Gated By Screen button to Select the Z (gate) Source Channel. The general purpose knob sets the Z-channel threshold level. Z-channel signals above the set threshold are true and open the XY signal gate; Z-channel signals below the set threshold are false and close the XY signal gate. The gating channel is always a high-true logic; to emulate a low-true gating logic, use the Vertical menu to invert the Z-channel signal.

XY and XYZ Cursors. (See page 74, *XY Cursor Menu*.)

Hard Copy



Push the hard copy button at the left of the display to make a hard copy. You can also store hard-copy images on a USB flash drive (in normal or compressed format) and then transfer them later to a PC for printing or use in a report.

Connecting a Printer

Use the rear-panel RS-232 (available on the optional communication module), or Ethernet port to connect your oscilloscope to a printer.

Setting Up to Print

To set up the oscilloscope to print a hard copy, follow these steps:

1. Push the **Utility** menu button.
2. Push the **System** bottom button to select **Hard Copy**.
3. Push the **Format** screen button and then choose the printer format appropriate for your application.
4. Push the **Options** screen button to select the image orientation (portrait or landscape) as well as turn on or off hard copy file compression.
5. Push the **Ink Saver** screen button and select **On** for most applications. If you want the hard copy colors to be the same as the screen colors, you can select **Off**. (See page 79, *Ink Saver and Preview*.)
6. Push the **Port** screen button and select the port that your printer is connected to, or select **File** to save the hard copy on a USB flash drive. (See page 104, *Using a USB Flash Drive*.)
7. Push the hard copy button .

Key Points

Printer Formats. The oscilloscope supports the following printers and file formats.

Format	Description
Thinkjet	HP monochrome ink-jet printer
Deskjet mono	HP monochrome ink-jet printer
Deskjet color	HP color inkjet printer
Laserjet	HP monochrome laser printer
Epson	Epson 9-pin and 24-pin dot matrix printers, C60 and C80 inkjet printers
TIFF	*.tif Tag image file format
Interleaf	*.img Interleaf image object file format
RLE color	Windows color image file format
PCX mono	PC Paintbrush monochrome image file format
PCX color	PC Paintbrush color image file format
BMP mono	Windows monochrome image file format
BMP color	Windows color image file format
EPS mono	Encapsulated PostScript monochrome image
EPS color	Encapsulated PostScript color image
Bubble Jet	Canon BJC-50, BJC-80 color printers
DPU-3445	Seiko DPU-3445 thermal printer
PNG color	Portable Network Graphics color image

Hard Copy File Compression. When compression is set to On, the oscilloscope compresses the hard copy data, using the current printer format, into a gnuzip file format, with the extension .gz. The .gz files can be decompressed using PKZIP or WinZip programs.

Color and Gray-Scale Printing. You can print a color hard copy that uses the display colors. Gray-scale waveform information is printed as shades of color. If you have a Deskjet or Laserjet monochrome printer, gray-scale waveform information is printed as a dithered image.

Ink Saver and Preview. As an alternative to printing the display colors, turn on the Ink Saver function to print a hard copy with a white background. This function saves printer ink while it preserves the color coding of the waveforms and readouts, except for channel 1. Because yellow ink is hard to see on white paper, Ink Saver prints channel 1

using a dark blue ink. Ink saver also works with the monochrome print formats.

Push and hold the Preview screen button to show how the colors will appear on the paper.

Clear Spool. You can push the Clear Spool screen button to empty the print spooler to stop a hard copy operation in progress, if the hard copy port connection is not made due to incompatible settings (such as baud rate), or if you lose the hard copy port connection before the hard copy is complete.

Date and Time Stamp. To print the current date and time on your hard copies, follow these steps:

1. Push the **Utility** button.
2. Push the **System** bottom button to select **Config**.
3. Push the **Set Date & Time** bottom button.
4. Set the **Display Date/Time** to **On** to add the current date and time to the display screen.
5. Push the **Menu Off** button.

Printer Error Message. To avoid printer errors, always power on the printer and allow it to complete its initialization process before powering on the oscilloscope. If you see a 'Hard copy device not responding' error message, power the oscilloscope off and then back on, and try to print again. If the printer still does not work, check that the printer is online, you have selected the correct printer format on the oscilloscope, there are no paper jams, and that the printer cable is firmly connected to the printer and oscilloscope.

Horizontal Controls

Use the horizontal controls to adjust the time base, adjust the trigger location, and to examine waveform details more closely.

Horizontal Position Control



When delay is off, the horizontal Position control moves the trigger point within the acquired waveforms. You can select full pretrigger, full posttrigger, or any point in between.

Use a pretrigger setting (trigger position near 100% of the record) to acquire waveforms leading up to a trigger event. For example, if you can trigger on an error condition, the waveforms leading up to the error condition might tell you why the error occurred.

Use a posttrigger setting (trigger position near 0% of the record) when you want to acquire waveforms that follow a trigger event. Use a mid-screen setting when you are interested in information both before and after the trigger event.

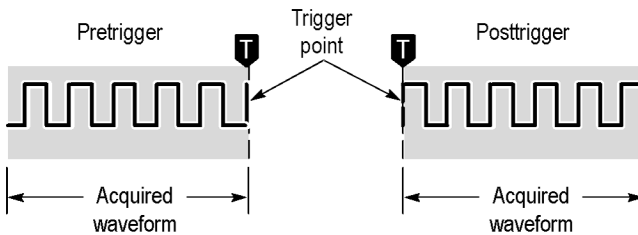

Refer to the *Reference* chapter for information about how the horizontal Position control operates when the Delay and Zoom functions are active. (See page 82, *Delay Button*.) (See page 84, *Zoom Button*.)

The trigger position is marked with the letter T at the top of the graticule and also in the waveform record icon at the top of the screen.

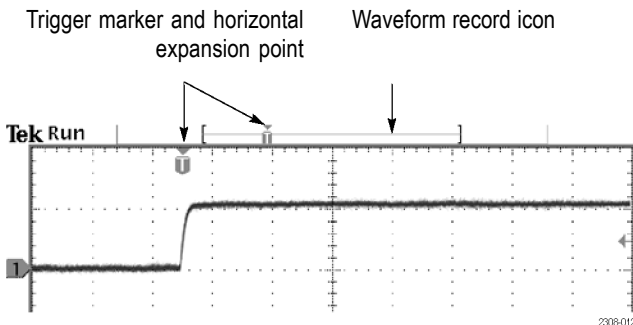

The small inverted triangle is the horizontal expansion point. When you change the horizontal Scale setting, the waveforms contract or expand about this point. When delay is off, the horizontal expansion point is the same as the trigger point.

Delay Button

Delay

Push the Delay button when you want to delay the acquisition relative to the trigger event. Turn the horizontal Position control counterclockwise to increase the delay; the trigger point moves to the left and ultimately outside of the acquired waveform. Then, you can adjust the horizontal Scale to acquire more detail around the area of interest (center of the screen).

When delay is on, the trigger point separates from the horizontal expansion point. The horizontal expansion point stays at the center of the screen. The trigger point can move off the screen; when this happens, the trigger marker turns to point in the direction of the trigger point.

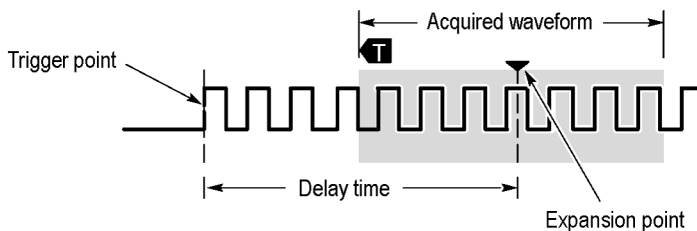

Use the delay feature when you want to acquire waveform detail that is separated from the trigger event by a significant interval of time. For example, you can trigger on a sync pulse that occurs once every 10 ms and then look at high-speed signal characteristics that occur 6 ms after the sync pulse.

In the next screen example, the trigger markers show that the trigger point is before the acquired waveform. The delay time, shown in the readout, is the time from the trigger point to the expansion point (center screen).

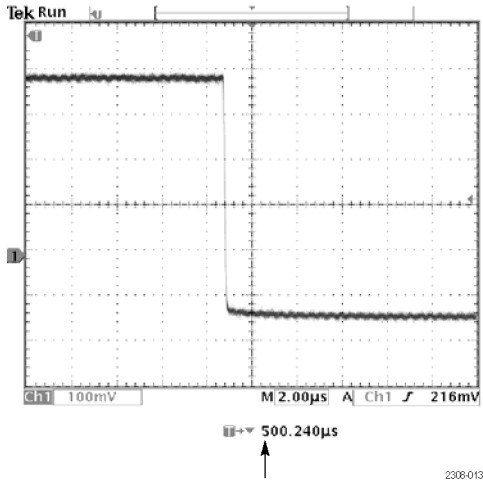

Delay time readout

The interaction between delay and other functions is summarized in the next table.

Function	Delay off	Delay on
Trigger point	Any point within the acquired waveform	Can occur prior to the acquired waveform
Expansion point	Same as the trigger point	Always center screen
Horizontal Scale	Sets time base	Sets time base
Horizontal Position	Sets trigger position in the acquired waveform	Sets delay time

Horizontal Scale Control



Use the horizontal Scale control to adjust the time base. When delay is off, the scale expands or contracts around the trigger point. When delay is on, the scale expands or contracts around the center of the screen. The *Reference* chapter includes possible exceptions. (See page 86, *Delay Interactions*.)

When the zoom function is active, use the horizontal Scale control to adjust the amount of horizontal magnification (the actual time-base

setting remains unchanged). The magnified waveforms always expand or contract around the center of the screen.

Zoom Button



Push the zoom button to magnify the current acquisition along the horizontal axis so you can see more detail. Use the horizontal Scale control to adjust the amount of magnification. Use the horizontal Position control to select the portion of the waveform you want to magnify. When zoom is on, changes you make to these controls do not affect the actual time base or trigger position settings.

The split screen shows the entire selected waveform in the upper window to give you a point of reference as you examine the details in the lower window.

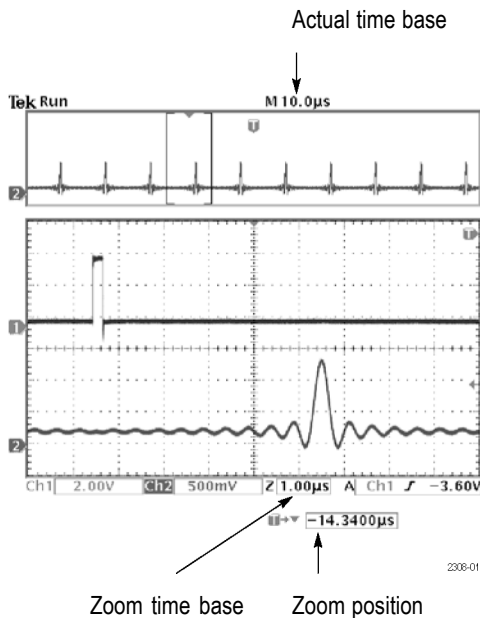

Key Points

Maximum Zoom Magnification Factor. If you are using Normal acquisition resolution, the maximum horizontal magnification factor is 200X; in Fast-trigger the maximum is 10X.

Horizontal Zoom and Preview. There are two ways you can magnify a stopped acquisition, horizontal zoom or preview. The differences in how horizontal zoom and preview interact with other functions are shown in the next table.

Function	Horizontal zoom	Horizontal preview
Horizontal Scale	Sets magnification factor	Changes time base for the next acquisition
Horizontal Position	Selects portion of waveform to magnify	Changes trigger position or delay time for the next acquisition
Delay button	Turns delay on and off	Turns delay on and off
Math waveform	Remains valid; magnifies and positions with other waveforms	Remains fixed; does not track changes to channel waveforms
Cursors and automatic measurements	Remain functional with valid readouts	Remain locked to channel waveforms
Gray-scale	Gray-scale information may be temporarily reduced	Gray-scale information is lost

Slow Horizontal Settings. At horizontal Scale settings of 40 ms/div or slower, the oscilloscope may display waveforms in roll mode. As the rolling waveform fills the screen, the waveform intensity and vector fill appears to decrease. The oscilloscope automatically reduces the number of displayed points in order to maintain a high acquisition rate: this does not represent a loss of acquired data.

When you stop the acquisition, the original waveform intensity and vector fill returns to the display.

Using Zoom and Delay Together. You can use both zoom and delay at the same time to magnify a delayed acquisition.

Fast Time-Base Settings. At the fastest time-base settings, only a portion of the waveform shows in the display. The waveform record icon indicates that portion with brackets. Push the zoom  button and then use the horizontal Position control to scroll through the entire waveform

to see any portion you want. The affected time-base settings are shown in the next table.

Acquisition resolution	Affected time-base settings
Normal	100 ns/div to 1 ns/div
Fast Trigger	4 ns/div to 1 ns/div

At the fastest time-base settings, the maximum zoom magnification factor is also reduced.

Delay Interactions. The maximum delay setting is a function of the time-base setting and acquisition resolution. If you set a large positive or negative delay, that amount of delay might be automatically reduced if you make the following additional control changes:

- Change to a faster time-base setting
- Change from Fast Trigger to Normal acquisition resolution

If the delay reduction occurs, it may cause the waveform horizontal position to shift.

Negative Delay. You can select up to ten divisions of negative delay. At the fastest time base settings, you can use negative delay to see more of the waveform that occurs before the trigger point.

Roll Mode Display. To obtain a rolling display similar to a strip-chart recorder, turn off zoom and delay, select the Auto trigger mode, and set the horizontal Scale control to 40 ms/div or slower. Subsequent changes to the horizontal Scale cause the roll-mode display to erase and restart.

Math and FFT

Math

Math and FFT functions are part of the Vertical menu group.

Math Waveform

Push the Math button to define the math waveform using the math menu. Also push the Math button to display or select the math waveform. The bottom menu will show other menu items when you have a TDS3AAM application module installed.

Bottom	Side	Description
Dual Wfm Math	Set 1st Source to	Selects the first source waveform.
	Set Operator to	Selects the math operator: +, -, ×, or ÷
	Set 2nd Source to	Selects the second source waveform.

Key Points

Dual-Waveform Math. For the dual-waveform math operations, the two source waveforms interact with the math operators in the sequence shown next.

Operation	Expression of math waveform
+	Source 1 + Source 2
-	Source 1 - Source 2
×	Source 1 × Source 2
÷	Source 1 ÷ Source 2

Scaling and Positioning the Math Waveform. To position or scale a math waveform, select the math waveform and then adjust it with a vertical Position or Scale control. You can do this whether acquisition is running or is stopped.

Math Interaction with Preview. If you select a channel waveform and then adjust the vertical Position or Scale control while the acquisition is stopped, the math waveform remains fixed. It does not track the changes you see to the channel waveform. The same is true if you adjust the horizontal Position or Scale control under these conditions.

Gray-Scale Restriction. Math waveforms are always based on the most current acquisitions and do not contain any gray-scale information.

Source Waveform Screen Position. When displaying dual-waveform math waveforms, make sure that the source waveforms do not extend beyond the top or bottom edge of the screen. If part of the source waveform is positioned outside the screen, the math waveform may not display correctly.

FFT Waveform

The FFT (Fast Fourier Transform) function mathematically converts the standard time-domain signal (repetitive or single-shot acquisition) into its frequency components, providing spectrum analysis capabilities. You can use the FFT function to look at the frequency components and spectrum shape of a signal:

- To test impulse response of filters and systems
- To measure harmonic content and distortion in systems
- To identify and locate noise and interference sources
- To analyze vibration
- To analyze harmonics in 50 and 60 Hz power lines

The FFT function provides the following features:

- **FFT Windows** – Four FFT windows (Rectangular, Hamming, Hanning, and Blackman-Harris) let you match the optimum window to the signal you are analyzing. The Rectangular window is best for nonperiodic events such as transients, pulses, and one-shot acquisitions. The Hamming, Hanning, and Blackman-Harris windows are better for periodic signals.
- **Analyze Repetitive, Single-Shot, and Stored Waveforms** – You can display an FFT waveform on any actively-acquired signal (periodic or one-shot), on the last acquired signal, or on any signal stored in reference memory.
- **dB or Linear RMS Scales** – The FFT vertical graticule can be set to either dB or Linear RMS. A dB scale is useful when the frequency component magnitudes cover a wide dynamic range, letting you show both lesser and greater- magnitude frequency components on the same display. A Linear scale is useful when the frequency component magnitudes are all close in value, allowing direct comparison of their magnitudes.
- **Time Signals and FFT Waveforms Displayed Together** – The time signals and FFT waveforms can be shown together on the display. The time signal highlights the problem; the FFT waveform helps you determine the cause of the problem.

Displaying an FFT Waveform. To display an FFT waveform, follow these steps:

1. Set the source signal Vertical Scale so that the signal peaks do not go off screen. Off-screen signal peaks can result in FFT waveform errors.
2. Set the Horizontal Scale control to show five or more cycles of the source signal. Showing more cycles means the FFT waveform shows more frequency components, provides better frequency resolution, and reduces aliasing. If the signal is a single-shot (transient) signal, make sure that the entire signal (transient event and ringing or noise) is displayed and centered on the screen.
3. Push the Vertical **Math** button to show the math menu.
4. Push the **FFT** screen button to show the FFT side menu.

Bottom	Side	Description
FFT	Set FFT Source to	Sets the FFT signal source. Valid input sources are Ch1 and Ch2 (2-channel instruments), Ch1 through Ch4 (4-channel instruments), and Ref1 through Ref4.
	Set FFT Vert Scale to	Sets the display vertical scale units. Available scales are dBV RMS and Linear RMS.
	Set FFT Window to	Sets which window function (Hanning, Hamming, Blackman-Harris, or Rectangular) to apply to the source signal. (See page 90, <i>FFT Windows</i> .)

5. Select a signal source. You can do an FFT on any channel or any stored reference waveform.
6. Select the appropriate vertical scale and FFT window.
7. Use zoom controls and the cursors to magnify and measure the FFT waveform.

FFT Windows. Applying a window function to the source waveform record changes the waveform so that the start and stop values are close to each other, reducing FFT waveform discontinuities. This results in an FFT waveform that more accurately represents the source signal frequency components.

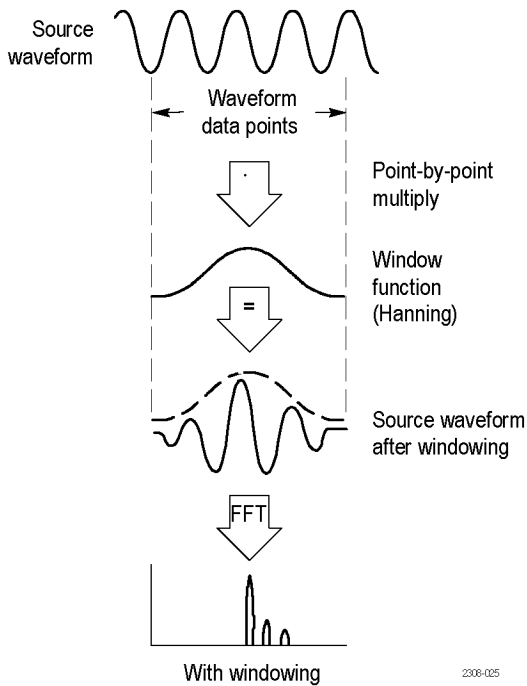

The shape of the FFT window determines how well the window resolves frequency or magnitude information.

FFT window	Characteristics	Best for measuring
Blackman-Harris	Best magnitude, worst at resolving frequencies.	Predominantly single frequency waveforms to look for higher order harmonics.
Hamming, Hanning	Better frequency, poorer magnitude accuracy than Rectangular. Hamming has slightly better frequency resolution than Hanning.	Sine, periodic, and narrow-band random noise. Transients or bursts where the signal levels before and after the event are significantly different.
Rectangular	Best frequency, worst magnitude resolution. This is essentially the same as no window.	Transients or bursts where the signal levels before and after the event are nearly equal. Equal-amplitude sine waves with frequencies that are very close. Broad-band random noise with a relatively slow varying spectrum.

Aliasing. Problems occur when the oscilloscope acquires a signal containing frequency components that are greater than the Nyquist frequency (1/2 the sample rate). The frequency components that are above the Nyquist frequency are undersampled and appear to "fold back" around the right edge of the graticule, showing as lower frequency components in the FFT waveform. These incorrect components are called aliases.

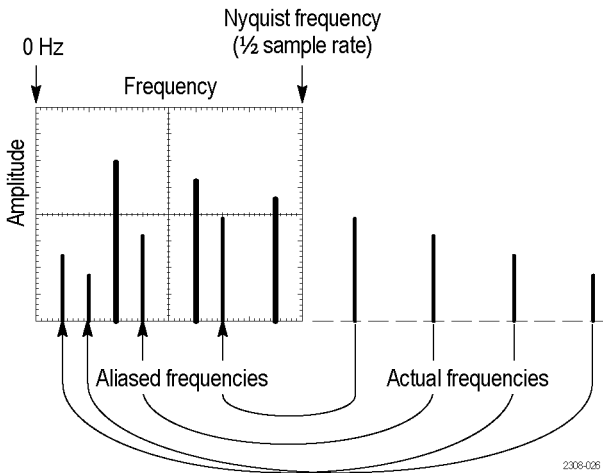

You can use the following methods to eliminate aliases:

- Increase the sample rate by adjusting the Horizontal Scale to a faster frequency setting. Since you increase the Nyquist frequency as you increase the horizontal frequency, the aliased frequency components should appear at their proper frequency. If the increased number of frequency components shown on the screen makes it difficult to measure individual components, push the zoom button  to magnify the FFT waveform.
- Use a filter on the source signal to bandwidth limit the signal to frequencies below that of the Nyquist frequency. If the components you are interested in are below the built-in bandwidth settings (20 MHz bandwidth for all oscilloscopes, 150 MHz bandwidth for 300 MHz and 500 MHz oscilloscopes), set the source signal bandwidth to the appropriate value. Push the Vertical Menu button to access the source channel bandwidth menu.

Key Points

FFT Source. To select the source, push the side menu button. Available sources are the channels and reference waveforms.

- Using FFT slows down the oscilloscope's response time in Normal acquisition mode (10k record length).
- A waveform acquired in Normal acquisition mode has a lower noise floor and better frequency resolution than a waveform acquired in Fast Trigger mode.
- Signals that have a DC component or offset can cause incorrect FFT waveform component magnitude values. To minimize the DC component, choose AC Coupling on the source signal.
- To reduce random noise and aliased components in repetitive or single-shot events, set the oscilloscope acquisition mode to average over 16 or more samples. Average mode attenuates signals not synchronized with the trigger.
- Do not use the Average acquisition mode if the source signal contains frequencies of interest that are not synchronized with the trigger rate.
- Do not use Peak Detect and Envelope modes with FFT. Peak Detect and Envelope modes can add significant distortion to the FFT results.
- For transient (impulse, one-shot) signals, set the oscilloscope to trigger on the transient pulse in order to center the pulse information in the waveform record.

FFT Vertical Scale. To select the vertical scale, push the side menu button. Available scales are dBV RMS and Linear RMS.

- Use the Vertical Position and Scale knobs to vertically move and rescale the FFT waveform.
- To display FFT waveforms with a large dynamic range, use the dBV RMS scale. The dBV scale displays component magnitudes using a log scale, expressed in dB relative to $1 V_{\text{RMS}}$, where $0 \text{ dB} = 1 V_{\text{RMS}}$, or in source waveform units (such as amps for current measurements).
- To display FFT waveforms with a small dynamic range, use the Linear RMS scale. The Linear RMS scale lets you display and directly compare components with similar magnitude values.

Nyquist Frequency. To determine the Nyquist frequency, push the Acquire menu button. This displays the current sample rate on the bottom right area of the screen. The Nyquist frequency is one-half of the sample rate. For example, if the sample rate is 25.0 MS/s, then the Nyquist frequency is 12.5 MHz.

Zooming an FFT Display. Use the Zoom button , along with horizontal Position and Scale controls, to magnify FFT waveforms. When you change the zoom factor, the FFT waveform is horizontally magnified about the center vertical graticule, and vertically magnified about the math waveform marker. Zooming does not affect the actual time base or trigger position settings.

NOTE. *FFT waveforms are calculated using the entire source waveform record. Zooming in on a region of either the source or FFT waveform will not recalculate the FFT waveform for that region.*

Measuring FFT Waveforms Using Cursors. You can use cursors to take two measurements on FFT waveforms: magnitude (in dB or signal source units) and frequency (in Hz). dB magnitude is referenced to 0 dB, where 0 dB equals $1 V_{\text{RMS}}$. Use horizontal cursors (H Bars) to measure magnitude and vertical cursors (V Bars) to measure frequency

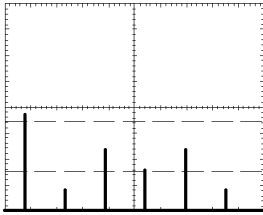

Magnitude cursors

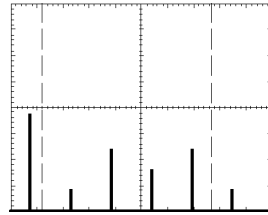

Frequency cursors

Measure

Meas

Push the Meas button to show the measure menu.

Bottom	Side	Description
Select Measurement		See the table on automatic measurements. (See page 98.)
Remove Measurement	Measurement 1 Measurement 2 Measurement 3 Measurement 4	Removes a specific measurement.
	All Measurements	Removes all measurements.
Gating	Off	Use to take measurements on the full waveform record.
	Screen	Use to take measurements on the portion of the waveform on screen.
	Cursors	Use to take measurements on the portion of the waveform between the V Bar cursors.
	Bring Selected Cursor to Center Screen	Moves the active cursor to center screen.
	Bring Both Cursors On Screen	Moves any off-screen cursor onto the screen.

Bottom	Side	Description
High-Low Setup	Auto Select	Automatically uses the best measurement method depending on the signal characteristics.
	Histogram	Use to measure pulses.
	Min-Max	Use to measure other wave shapes.
Reference Levels	Set Levels in % or units	Use to choose custom reference levels in relative or absolute units.
	High Reference	Sets custom high reference level.
	Mid Reference	Sets custom mid reference level.
	Mid 2 Ref	Sets the custom mid reference level for the Delay and Phase measurement second waveform.
	Low Reference	Sets custom low reference level.
	Set to Defaults	Sets reference levels to default values.
Indicators	Measurement 1-Measurement 4	Selects the measurement for which to display markers that show the portion of the waveform used to calculate the measurement value.
	Off	Turns measurement indicators off.

Key Points

Choosing Measurements. You can perform up to four automatic measurements and display them along the right side of the graticule. All four measurements can apply to a single channel or you can spread the measurements over several channels. You can also take measurements on math and reference waveforms.

First push a channel, Math, or Ref button to select the waveform you want to measure and then select a measurement. (See page 98, *Automatic Measurements*.)

Measurement Interaction with Preview. If you change a vertical or horizontal control setting while acquisition is stopped or is waiting for trigger, measurements track the changes and remain valid.

Taking Gray-Scale Measurements. Using cursors is often the best way to take simple measurements on waveforms that contain significant gray-scale information. The automatic measurements operate only on the latest acquisition, not on the previous acquisitions that are displayed in gray scale. However, you can set the cursors to surround and measure the gray-scale area of the waveform.

High-Low Setup. The oscilloscope determines the 10%, 50%, or 90% levels of the waveform and then uses them to calculate the measurements. There are two possible methods: Histogram or Min-max. Auto Select allows the oscilloscope to determine the method used.

- Histogram sets the values statistically; it finds the most common value either above or below the midpoint (depending on whether it is defining the high or low reference level). Since this statistical approach ignores short-term aberrations (overshoot, ringing, noise), histogram is the best method for measuring digital waveforms and pulses.
- Min-max uses the highest and lowest values of the waveform record. This method is best for measuring waveforms that have no large, flat portions at a common value, such as sine waves and triangle waves.
- Auto Select chooses one of the above methods automatically depending on the signal characteristics. Auto Select chooses the histogram method if the histogram contains prominent peaks. If not, Auto Select chooses the min-max method.

Measurement Gating. You can use the gating feature to limit measurements to the portion of the waveform that is on the screen or between the cursors.

When you turn Screen gating on, the oscilloscope only uses the waveform points on screen in its measurements. This function is useful at the fastest time base settings or when you want to take measurements on a magnified waveform (when zoom  is on).

When you turn Cursor gating on, the oscilloscope displays vertical bar cursors. Use the general purpose knob and Select button to place the cursors around the area of interest.

In the next example, the cursors surround the second positive-going pulse so the oscilloscope can measure the width of that pulse.

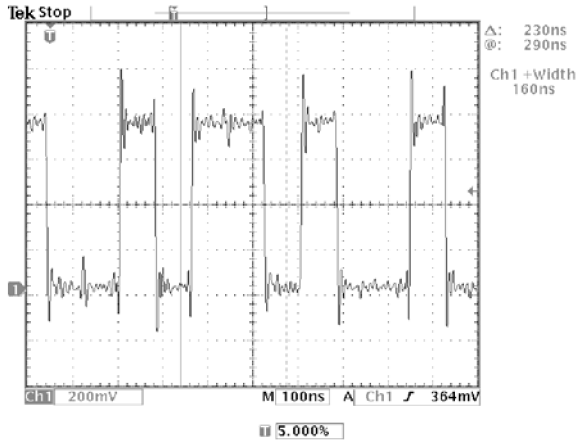



















When gating is off, the oscilloscope takes measurements over the entire waveform record.







Using Measurement Gating with Cursors. If V Bar cursors are already on when you select Cursor gating, the cursors do both functions at the same time. The cursor readouts are displayed at the same time that the cursors gate the automatic measurements.

If H Bar cursors are on when you select cursor gating, the H Bar cursors are turned off.

Automatic Measurements. The next table describes the measurements available when you push the Select Measrmtnt bottom screen button.

Measurement name	Definition
 Period	Time it takes for the first complete signal cycle to complete in the waveform. Measured in seconds.
 Frequency	Reciprocal of the period of the first cycle in the waveform. Measured in Hertz (Hz).
 Delay	Timing measurement. The time between the MidRef crossings of two different waveforms or the gated region of the waveforms.

Measurement name	Definition
 Rise Time	Time that the leading edge of the first pulse in the waveform takes to rise from 10% to 90% of its amplitude.
 Fall Time	Time that the falling edge of the first pulse in the waveform takes to fall from 90% to 10% of its amplitude.
 Positive Duty Cycle	Measurement of the first cycle in the waveform. <i>Positive Duty Cycle = Positive Width/Period × 100%</i>
 Negative Duty Cycle	Measurement of the first cycle in the waveform. <i>Negative Duty Cycle = Negative Width/Period × 100%</i>
 Positive Pulse Width	Measurement of the first positive pulse in the waveform; time between the 50% amplitude points.
 Negative Pulse Width	Measurement of the first negative pulse in the waveform; time between the 50% amplitude points.
 Burst Width	The duration of a burst. Measured over the entire waveform.
 Phase	Timing measurement. The amount one waveform leads or lags another in time. Expressed in degrees, where 360° comprise one waveform cycle.
 Positive Overshoot	Measured over the entire waveform. <i>Positive Overshoot = (Max-High)/Amplitude × 100%</i>
 Negative Overshoot	Measured over the entire waveform. <i>Negative Overshoot = (Low-Min)/Amplitude × 100%</i>
 Pk-Pk	Measured over the entire waveform. <i>Peak-to-peak = Max - Min</i>
 Amplitude	Measured over the entire waveform. <i>Amplitude = High (100%) - Low (0%)</i>
 High	The value used as 100%. Calculated using either the min/max or the histogram method. Measured over the entire waveform.
 Low	The value used as 0%. Calculated using either the min/max or the histogram method. Measured over the entire waveform.
 Max	The maximum amplitude. The most positive peak voltage measured over the entire waveform.

Measurement name	Definition
 Min	The minimum amplitude. The most negative peak voltage measured over the entire waveform.
 Mean	The arithmetic mean over the entire waveform.
 Cycle Mean	The arithmetic mean over the first cycle in the waveform.
 RMS	The true Root Mean Square voltage over the entire waveform.
 Cycle RMS	The true Root Mean Square voltage over the first cycle in the waveform.
 Area	Voltage over time that returns the area over the entire waveform or gated region in volt-seconds. The area measured above ground is positive, and below ground is negative.
 Cycle Area	Area over the first cycle in the waveform or the first cycle in the gated region expressed in volt-seconds. The area measured above the common reference point is positive, and below the point is negative.
Snapshot All Measurements	Displays all measurement values (except two-channel measurements) at the time you pushed the Snapshot All Measurements button, for the selected waveform. Push the Snapshot All Measurements button to update the list values. Push the Menu Off button to clear the list from the screen.

QuickMenu

 Push the QuickMenu button to see a set of frequently used menu functions on the display. QuickMenus simplify oscilloscope operation and can increase your productivity.

Scope is a standard QuickMenu for general purpose oscilloscope use. Some optional application packages also include a custom QuickMenu display. (See page 26, *Using the Scope QuickMenu*.)

Key Points

Using the QuickMenus. To use a QuickMenu, push the screen button that corresponds to the control you need to set. Push the screen button repeatedly to choose one of the settings. The small arrow icon indicates that there are additional settings available that are not shown.

You can use most of the front-panel controls at the same time you are using a QuickMenu. For example, if you push a channel button to select a different channel, the QuickMenu changes to show information about that channel.

Using Other Menus. You can still use the regular menus. For example, if you push the Meas button, you can set up and take automatic waveform measurements in the usual way. If you return to the QuickMenu, the measurement is still displayed on the screen.

Selecting Between QuickMenus. You may have optional application modules installed that also have QuickMenu displays. To select the QuickMenu you want to use, push the Menu screen button. This menu item is shown only if application modules that contain a QuickMenu are installed.

Save/Recall

**Save/
Recall**

Push the Save/Recall button to show the save/recall menu.

Bottom	Side	Description
Save	To File	Saves a setup to a USB flash drive.
Current Setup	To Setup 1 ... To Setup 10	Saves a setup to nonvolatile memory.
Recall	From File	Recalls a setup from a USB flash drive.
Saved Setup	Recall Setup 1 ... Recall Setup 10	Recalls a setup from nonvolatile memory.
Recall Factory Setup	OK Confirm Factory Init	Initializes the setup.

Bottom	Side	Description
Save Wfm	To File	Saves one or more waveforms to a file. Selecting this menu item changes the side menu contents. (See page 102.)
	To Ref1 ... To Ref4	Saves the selected waveform to nonvolatile memory. (See page 103.)
Recall Wfm	From File	Recalls a waveform from a USB flash drive and displays it as a reference waveform.
	Ref1 ... Ref4	Recalls a reference waveform.
File Utilities	Accesses the USB flash drive file utilities. (See page 104.)	
Labels	Lets you assign unique labels to reference waveforms and oscilloscope setups stored in nonvolatile memory. (See page 105.)	

Key Points

Saving Setups. To save the current setup to nonvolatile memory, push the Save Current Setup screen button, and then select one of the ten storage locations. Then, push the OK Overwrite Saved Setup screen button to complete the operation or the Menu Off button to cancel the operation.

Recalling Setups. To recall a setup from nonvolatile memory, push the Recall Setup screen button and then select one of the ten storage locations.

Recalling the Factory Setup. Recall the factory setup to initialize the oscilloscope to a known setup. *Appendix B* describes the Factory Setup in detail.

To recall the factory setup, push the Recall Factory Setup screen button, and then push the OK Confirm Factory Init screen button to complete the operation.

Saving a Waveform to File. When you push the **To File** side menu button, the oscilloscope changes the side menu contents. The next table describes these side menu items for saving data to a USB flash drive file.

Side menu button	Description
Internal File Format	Sets the oscilloscope to save waveform data to a USB flash drive in internal waveform save file (.isf) format. This format is the fastest to write and creates the smallest-sized files. Use the internal waveform format if you intend to recall a waveform and store it into reference memory for viewing or measuring.
Spreadsheet File Format	Sets the oscilloscope to save waveform data to a USB flash drive as a comma-separated data file compatible with most spreadsheet programs.
Mathcad File Format	Sets the oscilloscope to save waveform data to a USB flash drive in Mathcad format. Use this format if you intend to import the waveform data into Mathcad software.
Save Active Waveforms to Consecutive Files	Immediately saves all active waveforms to consecutively-numbered files in internal save file (.isf) format. This menu item is only available when the Internal File Format is selected.
Save Active Waveforms to Selected File	Immediately saves all active waveforms to a single spreadsheet or Mathcad format file. This menu item is only available when either spreadsheet or Mathcad file format is selected.
Save <wfm> to selected file	Immediately saves the selected active waveform, math waveform, or reference waveform data to a USB flash drive using the selected file format.

Saving a Waveform to Reference Memory. To save a waveform to nonvolatile memory, first select the waveform you want to save. Push the Save Wfm screen button and then select one of the four reference waveform locations. (See page 142.)

Saved waveforms contain only the most current acquisition; gray-scale information, if any, is not saved.

Displaying a Reference Waveform. To display a waveform stored in nonvolatile memory, push the Ref button and then push the Ref1, Ref2, Ref3, or Ref4 screen button.

When a reference waveform is selected, it appears brighter than other reference waveforms. Reference waveforms do not contain gray-scale information.

Removing a Reference Waveform from the Display. To remove a reference waveform from the display, push the Ref button and then the Ref1, Ref2, Ref3, or Ref4 screen button to select a reference waveform. Push the Waveform Off button . The reference waveform is still in nonvolatile memory and can be displayed again.

Erasing All Setups and Waveforms. Refer to *TekSecure* for instructions on how to erase all setups and waveforms saved in nonvolatile memory. (See page 134.)

Using a USB Flash Drive

**Save/
Recall**

You can use the save and recall file functions with a USB flash drive. Push the Save/Recall button, and the File Utilities screen button. The next table shows the File Utilities submenu.

Bottom	Side	Description
File Utilities	Delete	Deletes a file.
	Rename	Renames a file.
	Copy	Copies a file to another directory.
	Print	Prints a file to a printer connected to one of the hard copy ports.
	Create Directory	Creates a new directory.
	Confirm Delete	Turns On or Off a confirmation message before files are deleted.
	Overwrite Lock	Sets file overwrite protection to On or Off.
	Format	Formats a USB flash drive (erases all files).

Key Points

Upgrading Firmware. You can use a USB flash drive to upgrade the oscilloscope firmware or install new application packages. (See page xi.)

Navigating the File System. When you insert a USB flash drive and push the File Utilities screen button, the oscilloscope shows a list of directories and files on the flash drive.

Use the general purpose knob to select a directory or file. To change the working directory, select the directory and then push the Select button. To move up one directory level, select, and then push the Select button.

Automatic File Numbering. The oscilloscope gives all files created by the oscilloscope the default name TEK?????, where the question marks are placeholders for an automatic number sequence from 00000 to 99999.

You can change the TEK????? file to a new name with up to eight characters. If you use fewer than eight characters and include trailing question marks, the oscilloscope numbers the files sequentially if more than one are saved with the same base name.

For example, if you rename the TEK?????.ISF file to TEST?.ISF for a series of saved waveforms, the oscilloscope saves the first one as TEST00.ISF, the second one as TEST01.ISF, up to the last one as TEST99.ISF.

Editing File, Directory, Reference Waveform, or Instrument Setup Names. You can edit file names, directory names, reference waveform and oscilloscope setup labels, and Ethernet parameters. Use the general purpose knob to select an alphanumeric character. Use the screen buttons described in the next table to edit and enter the new name.

Screen button	Function
Enter Char	Enters the selected character into the field.
← and →	Moves the cursor to a different character in the field.
Back Space	Deletes the character before the cursor location.
Delete	Deletes the character at the cursor location.
Clear	Erases the current field value.
↑ and ↓	Selects the field that you want to edit.
OK Accept	Applies all field values.
Menu Off	Exits the menu without applying field values.

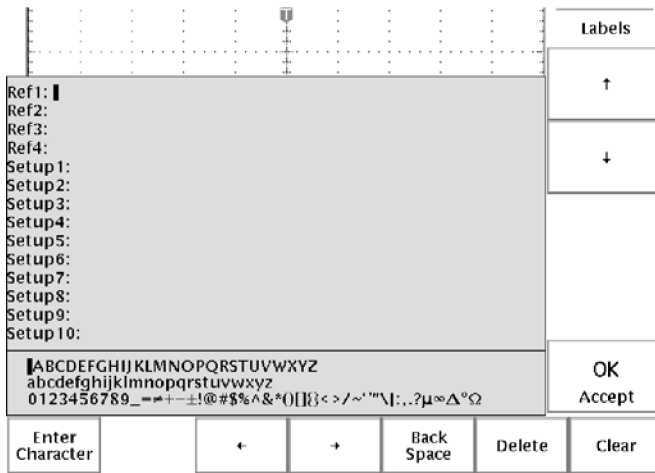

Deleting Files. To delete a file, select the file with the general purpose knob, push the Delete screen button, and then push the OK Delete screen button when you see the confirmation screen.

If you do not want to see a confirmation screen each time you delete a file, push the Confirm Delete screen button to set it to Off.

Renaming Files. To rename a file, select the file with the general purpose knob, push the Rename screen button, and then edit the file name. (See page 105.)

Once a directory is created, you cannot rename it. However, you can delete the directory and create a new one with a new name.

Copying Files and Directories. To copy a file or directory, select the file or directory with the general purpose knob and push the Copy screen button. Now use the general purpose knob and Select button to select a destination directory. Push the copy confirmation screen button to complete the operation.

Printing Files. You can print files through any installed printer port to your printer.

To print a file, select the file with the general purpose knob. Push the Print screen button and then select the port to which your printer is

connected. Make sure that the oscilloscope is set to send the correct file format to your printer.

Creating a Directory. To create a directory, use the general purpose knob and Select button to select the working directory where you want the new directory to reside. Push the Create Directory screen button, and enter or edit the file name using the screen buttons described in the previous table. (See page 105.)

Formatting a USB Flash Drive. To format a USB flash drive, insert it into the USB flash drive port. Push the Format screen button and then push the OK Confirm Format screen button to confirm the operation. If you decide not to format the flash drive, push the Menu Off button to stop the format operation.



CAUTION. *To avoid loss of data, do not format USB flash drives that already contain important data. When you format a USB flash drive, all files and directories will be erased and can never be recovered.*

Setting Protections. The oscilloscope provides two protections to help you prevent accidental loss of data:

- Confirm Delete shows a confirmation message each time you try to delete a file. You can turn Confirm Delete off if you do not want to see the message.
- Overwrite Lock prevents the oscilloscope from writing over existing files. You can turn Overwrite Lock off if you want to be able to write over existing files.

File Extensions. Files written by the oscilloscope have the following extensions. The oscilloscope can only read files with the SET, MSK, and ISF extensions.

File extension	File type
*.SET	Saved setup file
*.ISF	Saved waveform file, Internal format
*.CSV	Saved waveform file, Spreadsheet format
*.DAT	Saved waveform file, Mathcad format

File extension	File type
*.TJ	Hard copy file, Thinkjet format
*.DJ	Hard copy file, Deskjet format
*.LJ	Hard copy file, Laserjet format
*.IBM	Hard copy file, Epson format
*.IMG	Hard copy file, Interleaf format
*.TIF	Hard copy file, TIFF format
*.RLE	Hard copy file, RLE format
*.PCX	Hard copy file, PCX format
*.BMP	Hard copy file, BMP format
*.EPS	Hard copy file, EPS format
*.BJC	Hard copy file, Bubble Jet format
*.DPU	Hard copy file, Seiko DPU-3445 format
*.GZ	Gnuzip-compressed hard copy file
*.MSK	Mask geometry file (requires TDS3TMT module)
*.PNG	Hard copy file, Portable Network Graphics format
*.C60, *.C80	Hard Copy file, Epson C60 or C80 inkjet format

Trigger Controls

Menu

Push the Trigger Menu button, and then push the Type screen button to select Edge, Logic, Pulse, or Video. If installed, see the user manual for the TDS3VID Extended Video, the TDS3SDI 601 Digital Video, or the TDS3TMT Telecom Mask Test application module for more information.

Trigger Level



Use the trigger Level control to adjust the trigger level. When you change the trigger level, a horizontal line temporarily appears to show you the level on screen. After the line disappears, the trigger level is marked with a small arrow.

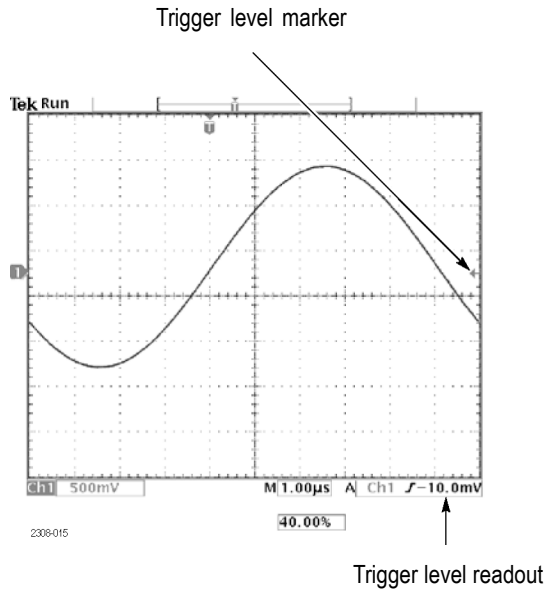

Set to 50%

Set to 50%

Push the Set To 50% button to set the trigger level to the 50% amplitude level of the trigger source waveform.

Force Trigger

Force Trig

Push the Force Trig button to force an immediate trigger event, even in the absence of a signal. This function is useful in these situations:

- If you do not see a waveform on the screen when using Normal trigger mode, push Force Trig to acquire the signal baseline to verify that it is on the screen.
- After you push the Single Seq button to set up for a single shot acquisition, you can push the Force Trig button to do a practice acquisition to verify the control settings.

B Trigger

B Trig

To use the B trigger, the A trigger type must be Edge. Push the Trigger Menu and then the B Trig buttons to show the B-trigger menu and to activate triggering using both the A and B triggers. The light next to the B Trig button indicates B trigger is active. Push the B Trig button again to return to the single A trigger.

Bottom	Side	Description
B Trigger After A	B Trigger After A Time	Sets the oscilloscope to trigger on the next B-trigger event that occurs after a specified period of time from the A trigger. Use the general purpose knob to set the time value.
	Set to Delay Time ($B \rightarrow \nabla$) then Set ($B \rightarrow \nabla$) to 0s	Sets the B Trigger After A Time value to the horizontal $B \rightarrow \nabla$ value, then sets $B \rightarrow \nabla$ to zero seconds. $B \rightarrow \nabla$ is the delay time from the B trigger point to the expansion point (center screen).
	Set to Min	Sets B Trigger After A time to 26.4 ns.
	B Events	Sets the oscilloscope to trigger on the n B-trigger event after the A trigger. Use the general purpose knob to set the event value.
	Set to Min	Sets the B events count to 1.
Source		Sets Source, coupling, slope, and level for the B trigger. These settings are independent of similar settings for the A trigger. The table on Edge triggering includes descriptions of these menu items. (See page 113.)
Coupling		
Slope		
Level		

The trigger wait time is the minimum time between the A and B triggers. The trigger wait time is not the same as the horizontal delay time. You can use the horizontal delay function to delay acquisition relative to any trigger event, whether it is from the A trigger alone or from a trigger set-up that involves both the A and B triggers.

The next figures show the wait-for-time and the wait-for-events triggering, and how they relate to the horizontal delay time.

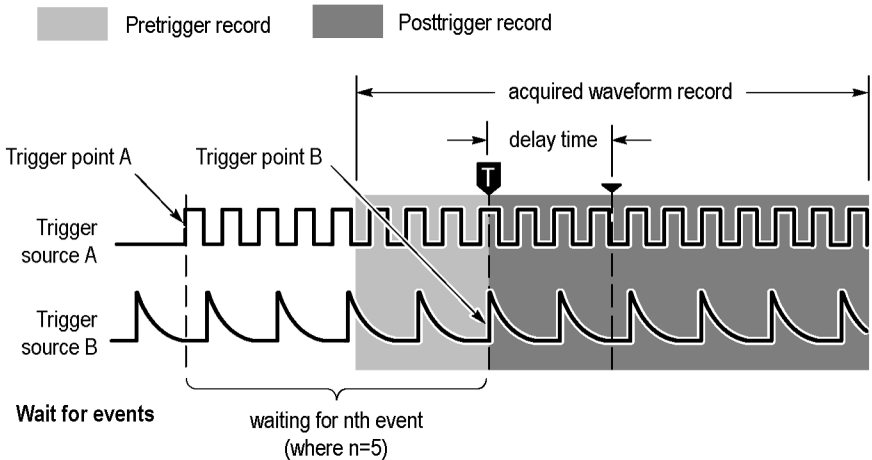
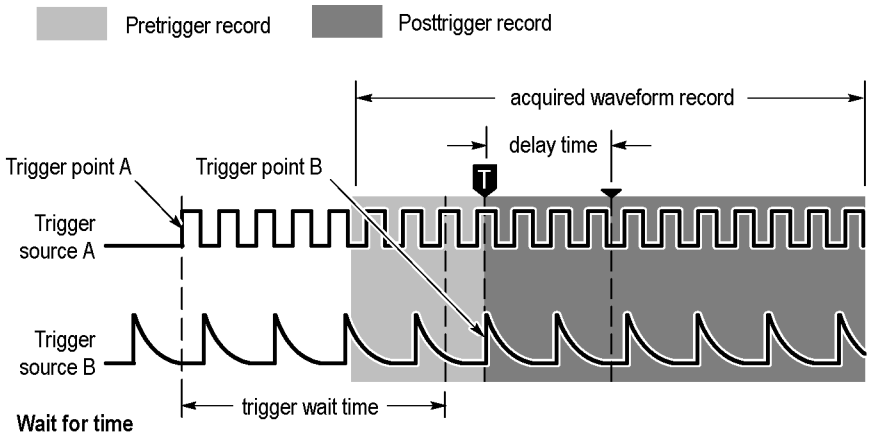

After the A trigger event is recognized, the oscilloscope begins counting B trigger events. However, for the first B event to be counted, that event must consist of both an opposite-polarity edge and the edge that is counted. The opposite-polarity edge must occur ≥ 5 ns after the A trigger arming event. If this condition is not met, the oscilloscope does not count the first event, which results in a trigger on the $n+1^{\text{st}}$ event. Refer to the next figure, where $n=3$ and A and B trigger slopes are set to rising edge.

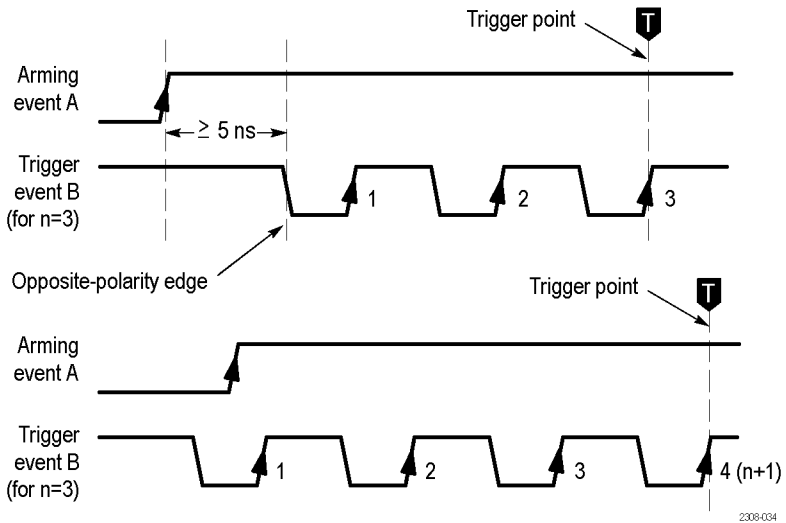

2308-C04

Trigger Status

The readout at the top of the screen shows you the current trigger status. The next table explains the trigger status indicators.

Trigger status	Explanation
Auto	The oscilloscope is acquiring using auto trigger. Valid trigger events, if any, are infrequent.
Trig'd	The oscilloscope is acquiring using valid trigger events that are frequent enough to avoid auto triggering.
PrTrig	The oscilloscope is acquiring the pretrigger part of the waveforms. This status is shown only at the slowest time/division settings.
Trig	The oscilloscope has acquired the pretrigger part of the waveforms and is waiting for a valid trigger event.
BTrig	The A trigger event has occurred. The oscilloscope is armed and waiting for a valid B trigger event.

Edge Trigger

Menu

Push the Trigger Menu button, and then push the Type bottom screen button to select Edge. Use Edge triggering to trigger on the rising or falling edge of the input signal at the trigger threshold. The next table lists the menu items when the trigger Type is set to Edge.

Bottom	Side	Description
Source	Ch1, Ch2 (Ch3, Ch4)	Sets the trigger source to a specific channel.
	AC Line	Sets the trigger source to use the AC line signal (not available when operating with batteries).
	Ext Ext/10	Sets the oscilloscope to trigger on the external trigger source. Ext/10 attenuates the external trigger signal by a factor of 10. (See page 114.)
	Ext Probe nnX Voltage / Current (4-channel only)	Set this value to match the attenuation factor and the type of probe (voltage or current) that is attached to the external trigger connector. Push the menu button to select the probe type. Use the general purpose knob to set the attenuation factor. The default values are 1x and voltage.
	Vert	Sets the trigger source to the lowest-numbered active channel in the display.
	Alternating (all active channels)	Sequentially uses each active channel as a trigger source, from the lowest-numbered active channel to the highest-numbered active channel. (See page 114.)
Coupling	DC	Selects DC coupling.
	HF Reject	Rejects frequencies above 30 kHz in the trigger signal.
	LF Reject	Rejects frequencies below 1 kHz in the trigger signal.
	Noise Reject	DC coupling with low sensitivity to reject noise in the trigger signal.
Slope	/ (rising edge)	Triggers on the rising edge of a signal.
	\ (falling edge)	Triggers on the falling edge of a signal.

Bottom	Side	Description
Level	Level	Use to set the trigger level with the general purpose knob.
	Set to TTL	Sets the trigger level to +1.4 V for TTL logic.
	Set to ECL	Sets the trigger level to -1.3 V for ECL logic ($V_{ee} = -5.2$ V).
	Set to 50%	Sets the trigger level to the 50% amplitude level of the signal.
Mode & Holdoff	Auto (untriggered roll)	Enables free-running and roll-mode acquisitions.
	Normal	Triggers only on valid trigger events.
	Holdoff (time)	Sets holdoff to a specific time.
	Holdoff (% of record)	Sets holdoff to a percent of the record duration.
	Set to Min	Sets holdoff to the minimum value.

Key Points

Displaying the Trigger Source. You do not have to display a channel to use it as a trigger source.

Normal and Auto Mode. Use Normal trigger mode when you want to trigger only on a valid event. Use Auto trigger mode when you want the acquisition to occur, even when there is not a valid trigger event. Also choose Auto when you want a rolling waveform, with no trigger, at the slower time base settings. (See page 86, *Roll Mode Display*.)

External Trigger. The trigger level range for the EXT setting is -0.8 V to +0.8 V. The trigger level range for the EXT/10 setting is -8 V to +8 V.

For best external trigger performance, apply a square-wave signal with amplitude greater than the specified minimum level range and with well-defined transitions.

Alternating Trigger. Alternating trigger sequentially uses each active channel as a trigger source, from the lowest-numbered active channel to the highest-numbered active channel. Alternating trigger is available in all trigger menus except for logic triggers.

Alternating trigger uses the current trigger settings to trigger on all active channels; there is not a separate trigger setup for each channel. Therefore, the trigger settings must be able to trigger on all active signals in order to produce a stable triggered display. If one or more of the source signals do not meet the trigger settings, the oscilloscope either waits for that source channel to trigger (Normal trigger mode) or autotrigger (Auto trigger mode).

Due to image persistence, all alternating trigger active channels may appear to be synchronized. However, this does not mean that the displayed signals are synchronized. Also, alternating trigger does not use EXT, EXT/10, or Line signals as trigger sources.

Holdoff. You can use holdoff to help stabilize the display of complex waveforms. After you push the Mode & Holdoff screen button, use the general purpose knob to set the holdoff time as an absolute value or as a percent of the record duration.

Holdoff begins when the oscilloscope recognizes a trigger event and disables the trigger system until acquisition is complete. The trigger system remains disabled during the holdoff time.

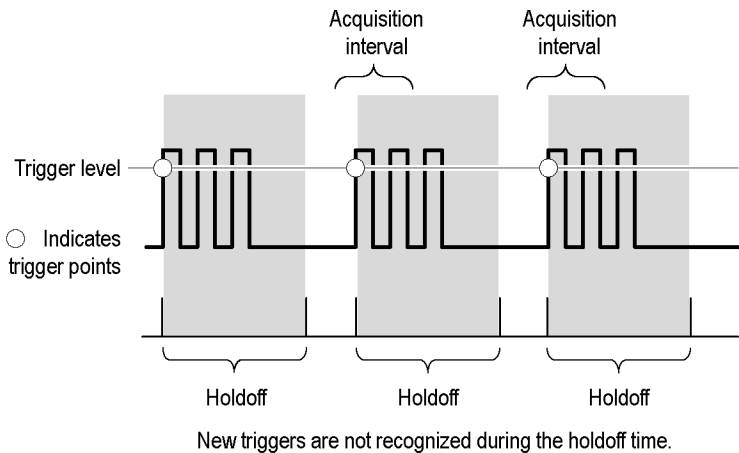

NOTE. For best results, choose Normal trigger mode when using long holdoff settings (10 ms or greater).

Logic Triggers

Edge triggering can trigger on most signals, and is the default trigger type. Edge triggering sets the oscilloscope to trigger (acquire signal data) when a signal meets a specified signal slope and a single voltage-threshold condition.

Single threshold voltage setting

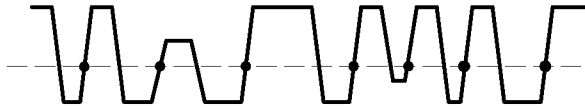

● = Possible trigger points for positive slope signals

2308-030

However, there are times when you need to trigger the oscilloscope on a more complex signal, or when two signals meet a condition to troubleshoot a problem. These problems include a pulse that is too narrow or wide, and situations in which one signal is true when a second signal transitions from low to high.

Logic and Pulse triggering lets you further qualify the trigger conditions by adding parameters such as pulse width, delta time, logical comparisons of two signals, and dual threshold levels.

Pulse width

Runt pulse

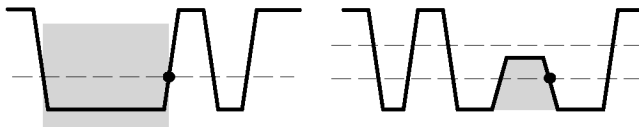

● = Trigger point

2308-031

Thresholds. Both Pulse and Logic types trigger the oscilloscope when one or two signals are logically true. To determine whether a signal is true or false, you must set a signal reference point that determines whether a signal is in one of two states. You set this reference point by specifying a threshold voltage level for each trigger signal. Crossing the threshold level toggles the state value of that signal.

Single threshold voltage setting

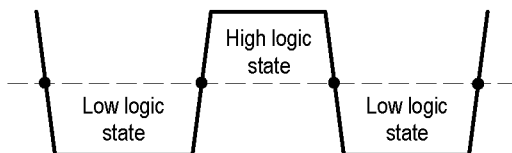

● = Transition point from one state to another

2308-017

Logic State. The actual state (true or false) of a signal depends on how you define its signal logic setting, which can be either high-true or low-true. Defining a signal as high-true (H) means that signal levels above (more positive than) the threshold level are true, and signal levels below (more negative than) the threshold level are false.

A low-true (L) logic setting is just the opposite. Defining a signal as low-true means that signal levels below (more negative than) the threshold level are true, and signal levels above (more positive than) the threshold level are false. Low logic effectively inverts the signal.

Defining the logical state of a signal lets you use Boolean logic to evaluate when a condition is true for two signals.

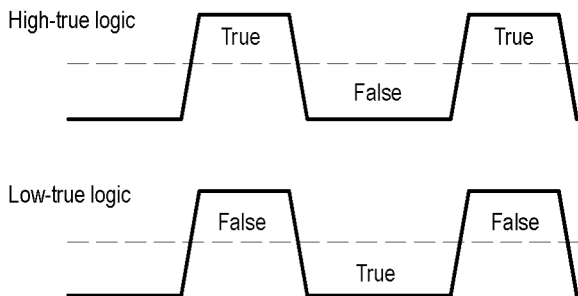

2308-018

Boolean Logic. The signal logic (threshold level and high-true/low-true logic) defines which part of a waveform cycle is true or false. You then use Boolean logic to evaluate or compare the logic of two signals as part of a trigger condition.

The four logical comparison functions are AND, OR, NAND, and NOR:

- The AND function means that if both signal logic states are true, the condition is true, otherwise the condition is false.
- The OR function means if either or both signal logic states are true, the condition is true, otherwise the condition is false.
- The NAND function means that if both signal logic states are true, the condition is false, otherwise the condition is true. This function is the inverse of the AND function.
- The NOR function means if any or all of the trigger signal logic states are true, the condition is false, otherwise the condition is true. This function is the inverse of the OR function.

Remember that the logic function evaluates the logic states of two signals, and that the logic state of each signal depends on whether they are set to high-true or low-true logic.

For example, assume that you want to trigger the oscilloscope only when signal one is low at the same time that signal two is high. Therefore you want to:

- Set a threshold level that is appropriate for each signal.
- Set signal one to be true when it is low (low-true signal logic).
- Set signal two to be true when the signal is high (high-true signal logic).
- Trigger when both conditions are true (AND trigger logic).

Trigger logic: Signal 1 AND Signal 2

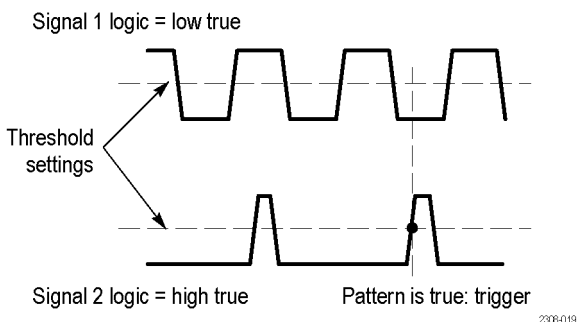

Conventions for Logic and Pulse Trigger Types. This manual uses the following conventions:

- You cannot use any of the advanced trigger functions to arm B triggering.
- You do not have to display a channel in order to use the channel as a trigger source.
- The range of time values for pulse width (regular and runt) and slew rate is from 39.6 ns to 10 s.
- In the menu tables, *N* represents a numeric value entered using the general purpose knob.

Pattern Trigger

Pattern triggering triggers the oscilloscope when two signals become logically true or false. Basically, the pattern-triggering feature triggers the oscilloscope from the output of a two-input AND, OR, NAND, or NOR logic gate. You can specify time constraints and signal threshold levels as part of the triggering condition. This trigger is useful for digital logic troubleshooting.

Pattern Trigger Conditions

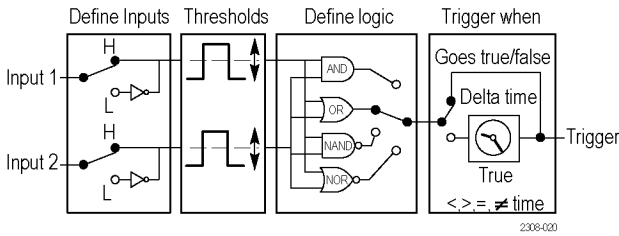

Menu

Push the Trigger Menu button, and then push the Type bottom screen button to select Logic. The next table lists the menu items when the trigger Type is set to Logic, and the Class is set to Pattern.

Bottom	Side	Description
Define Inputs	Input 1 Source	Sets the pattern trigger signal input 1 source.
	Logic	Sets the signal logic for input 1. H = high true, L = low true.
	Input 2 Source	Sets the pattern trigger signal input 2 source.
	Logic	Sets the signal logic for input 2. H = high true, L = low true.
Define Logic	AND, OR, NAND, NOR	Sets which logic function to apply to the input signals.
Trigger When	Goes True	Triggers the oscilloscope when the logic condition is true or false.
	Goes False	
	Is True < N	Triggers the oscilloscope when the input logic condition is true for a time period greater than or less than time period N.
	Is True > N	
	Is True = N	
Is True 0 N	Triggers the oscilloscope when the input logic condition is true for a time period equal to or not equal to time period N within a $\pm 5\%$ tolerance.	

Bottom	Side	Description
Thresholds	Level (Input 1) <i>N</i> Level (Input 2) <i>N</i>	Sets the threshold voltage level for input 1 and 2 to level <i>N</i> , using the general purpose knob.
	Set to TTL	Sets the threshold voltage level to 1.4 V for both inputs.
	Set to ECL	Sets the threshold voltage level to -1.3 V for both inputs.
	Set to 50%	Sets the threshold voltage level to 50% of each input's peak-to-peak value.
Mode & Holdoff		The table on Edge triggering includes a description of this menu item. (See page 113.)

Key Points

Trigger When. The input condition must be true or false for ≥ 2 ns in order for the oscilloscope to detect the pattern.

State Trigger

State triggering triggers the oscilloscope when a state signal is true or false at the time a clock signal transition is true. This trigger is useful for troubleshooting digital logic synchronous state machines.

State Trigger Conditions

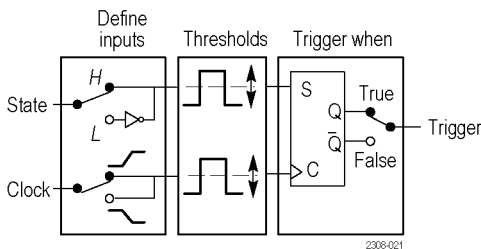

Menu

Push the Trigger Menu button, and then push the Type bottom screen button to select Logic. The next table lists the menu items when the trigger Type is set to Logic, and the Class is set to State.

Bottom	Side	Description
Define Inputs	State Input Source	Sets the state signal source.
	Logic	Sets the signal logic for state input source. H = high true, L = low true.
	Clock Input Source	Sets the clock signal source.
	Slope	Sets the signal slope (rising or falling) for clock input. The clock slope defines when the clock signal is true.
Trigger When	Goes True	Triggers the oscilloscope if the state signal is true when the clock signal slope is true.
	Goes False	Triggers the oscilloscope if the state signal is false when the clock signal slope is true.
Thresholds	Level (State Input) N	Sets the threshold voltage level for state and clock signals to level N , using the general purpose knob.
	Level (Clock Input) N	
	Set to TTL	Sets the threshold voltage level to 1.4 V for both inputs.
	Set to ECL	Sets the threshold voltage level to -1.3 V for both inputs.
	Set to 50%	Sets the threshold voltage level to 50% of each input's peak-to-peak value.
Mode & Holdoff	The table on Edge triggering includes a description of this menu item. (See page 113.)	

Key Points

Trigger When. The state signal must be true or false for ≥ 2 ns prior to the clock transition in order for the oscilloscope to detect the state.

Pulse Triggers

Pulse Width Trigger. Pulse-width triggering triggers the oscilloscope when a signal pulse width is less than, greater than, equal to, or not equal to a specified pulse width. This trigger is useful for digital logic troubleshooting.

Pulse Width Trigger Conditions

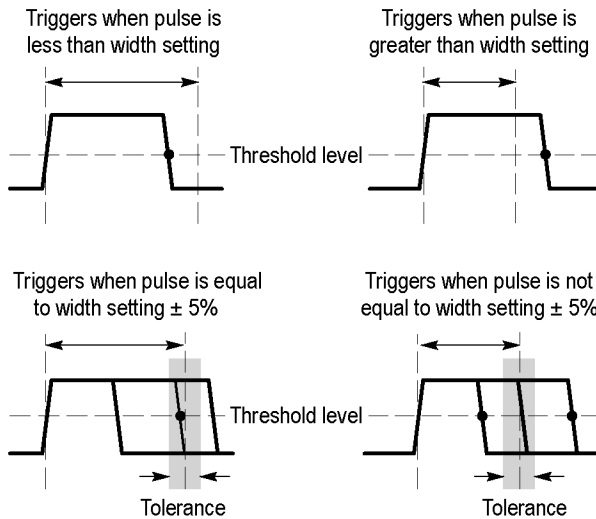

● = Trigger point

2308-022

Menu

Push the Trigger Menu button, and then push the Type bottom screen button to select Pulse. The next table lists the menu items when the trigger Type is set to Pulse, and the Class is set to Width.

Bottom	Side	Description
Source	Ch1, Ch2 (Ch3, Ch4)	Sets the pulse width signal source.
	Ext Ext/10	Sets external or external divided by 10 as the signal source.
	Ext Probe nnX Voltage / Current (4-channel only)	Set this value to match the attenuation factor and the type of probe (voltage or current) that is attached to the external trigger connector. Push the menu button to select the probe type. Use the general purpose knob to set the attenuation factor. The default values are 1x and voltage.
	AC Line	Sets the AC line frequency as the trigger source. This trigger source is only available when the oscilloscope is connected to AC power.
	Vert	Sets the lowest-numbered displayed channel as the trigger source.
	Alternating (all active channels)	Sequentially uses each active channel as a trigger source, from the lowest-numbered active channel to the highest-numbered active channel. (See page 114.)
Polarity	Positive	Sets the source signal pulse polarity on which to trigger.
	Negative	
Trigger When	Pulse Width < <i>N</i>	Triggers the oscilloscope when the source signal pulse width is less than or greater than the specified pulse width <i>N</i> .
	Pulse Width > <i>N</i>	
	Pulse Width = <i>N</i> Pulse Width ≠ <i>N</i>	
Level	Level <i>N</i>	Sets the signal threshold voltage level to <i>N</i> using the general purpose knob.
	Set to TTL	Sets the signal threshold voltage level to 1.4 V.
	Set to ECL	Sets the signal threshold voltage level to -1.3 V.
	Set to 50%	Sets the threshold voltage level to 50% of the signal's peak-to-peak value.
Mode & Holdoff		The table on Edge triggering includes a description of this menu item. (See page 113.)

Key Points

Trigger When. The source pulse width must be ≥ 5 ns in order for the oscilloscope to detect the pulse.

Runt Pulse Trigger

Runt-pulse triggering triggers the oscilloscope when a signal pulse is less than a specified threshold level. You can also specify runt pulse-width parameters. This trigger is useful for troubleshooting bus-contention problems.

Runt Pulse Trigger Conditions

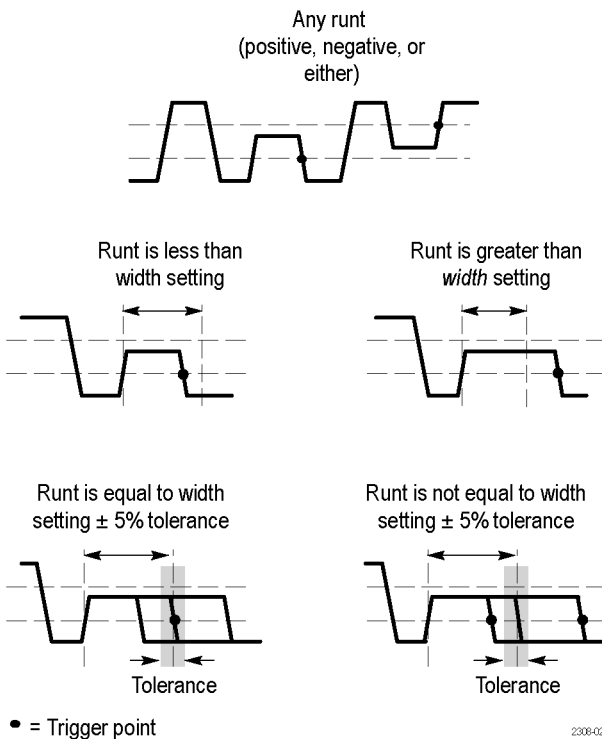

Menu

Push the Trigger Menu button, and then push the Type bottom screen button to select Pulse. The next table lists the menu items when the trigger Type is set to Pulse, and the Class is set to Runt.

Bottom	Side	Description	
Source	Ch1, Ch2 (Ch3, Ch4)	Sets the runt signal source.	
	Ext Ext/10	Sets external or external divided by 10 as the signal source.	
	Ext Probe nnX Voltage / Current (4-channel only)	Set this value to match the attenuation factor and the type of probe (voltage or current) that is attached to the external trigger connector. Push the menu button to select the probe type. Use the general purpose knob to set the attenuation factor. The default values are 1x and voltage.	
	AC Line	Sets the AC line frequency as the trigger source. This trigger source is only available when the oscilloscope is connected to AC power.	
	Vert	Sets the lowest-numbered displayed channel as the trigger source.	
	Alternating (all active channels)	Sequentially uses each active channel as a trigger source, from the lowest-numbered active channel to the highest-numbered active channel. (See page 114.)	
Polarity	Positive Negative Either	Sets the source signal runt pulse polarity on which to trigger.	
	Trigger When	Runt Occurs	Triggers the oscilloscope when any runt pulse is detected, regardless of width.
		Runt Width < N Runt Width > N	Triggers the oscilloscope when the runt signal pulse width is less than or greater than the specified pulse width N .
Runt Width = N Runt Width $\neq N$		Triggers the oscilloscope when the runt signal pulse width is equal to or not equal to the specified pulse width N within a $\pm 5\%$ tolerance.	

Bottom	Side	Description
Thresholds	High N	Sets the runt signal high threshold and low threshold voltage levels to value N , using the general purpose knob.
	Low N	
	Set to TTL	Sets runt signal threshold voltage levels to 2.0 V (high threshold) and 0.8 V (low threshold).
	Set to ECL	Sets runt signal threshold voltage levels to -1.1 V (high threshold) and -1.5 V (low threshold).
Mode & Holdoff		The table on Edge triggering includes a description of this menu item. (See page 113.)

Key Points

Trigger When. The source runt pulse width must be ≥ 5 ns in order for the oscilloscope to detect the pulse.

Slew Rate Trigger

Slew-rate triggering triggers the oscilloscope when a signal's slew rate (rise or fall time) is less than, greater than, equal to, or not equal to a specified slew rate. This trigger is useful for troubleshooting digital bus transceivers, transmission lines, and op-amp circuits.

Slew Rate Trigger Conditions

Signal slew rate is greater (faster) than specified slew rate

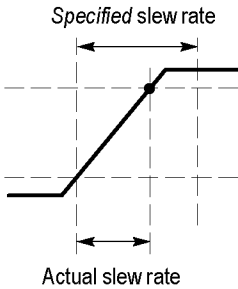

Signal slew rate is less (slower) than specified slew rate

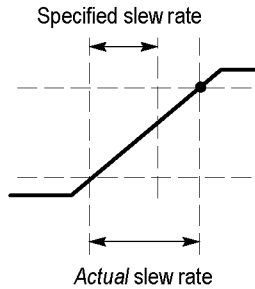

Signal slew rate is equal to specified slew rate $\pm 5\%$ tolerance

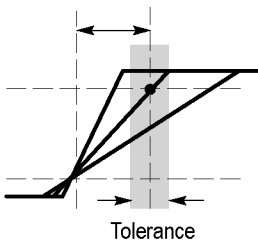

Signal slew rate is not equal to specified slew rate $\pm 5\%$ tolerance

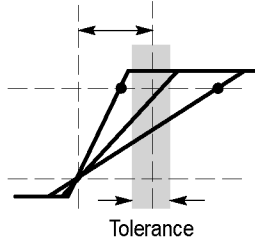

● = Trigger point

2308-024

Menu

Push the Trigger Menu button, and then push the Type bottom screen button to select Pulse. The next table lists the menu items when the trigger Type is set to Pulse, and the Class is set to Slew Rate.

Bottom	Side	Description	
Source	Ch1, Ch2 (Ch3, Ch4)	Sets the slew rate signal source.	
	Ext Ext/10	Sets external or external divided by 10 as the signal source.	
	Ext Probe nnX Voltage / Current (4-channel only)	Set this value to match the attenuation factor and the type of probe (voltage or current) that is attached to the external trigger connector. Push the menu button to select the probe type. Use the general purpose knob to set the attenuation factor. The default values are 1x and voltage.	
	AC Line	Sets the AC line frequency as the trigger source. This trigger source is only available when the oscilloscope is connected to AC power.	
	Vert	Sets the lowest-numbered displayed channel as the trigger source.	
	Alternating (all active channels)	Sequentially uses each active channel as a trigger source, from the lowest-numbered active channel to the highest-numbered active channel. (See page 114.)	
Polarity	Positive Negative Either	Sets the source signal slew rate polarity on which to trigger.	
	Trigger When	Slew Rate < N Slew Rate > N	Triggers the oscilloscope when the signal slew rate is less than or greater than the specified slew rate N .
		Slew Rate = N Slew Rate $\neq N$	Triggers the oscilloscope when the signal slew rate is equal to or not equal to the specified slew rate N within a $\pm 5\%$ tolerance.
Delta Time N		Shows the delta time component N of the slew rate, as set using the general purpose knob.	

Bottom	Side	Description
Thresholds	High <i>N</i>	Sets the signal high threshold and low threshold voltage level components of the slew rate to value <i>N</i> , using the general purpose knob.
	Low <i>N</i>	
	Set to TTL	Sets the signal threshold voltage levels to 2.0 V (high threshold) and 0.8 V (low threshold).
	Set to ECL	Sets the signal threshold voltage levels to -1.1 V (high threshold) and -1.5 V (low threshold).
Mode & Holdoff		The table on Edge triggering includes a description of this menu item. (See page 113.)

Key Points

Delta Time and Thresholds. The delta time and threshold settings determine the calculated slew rate (volts ÷ time). Changing either value changes the calculated slew rate.

Trigger When. The delta time component of the slew rate (time from threshold to threshold) must be ≥ 5 ns in order for the oscilloscope to detect the slew rate.

Video Trigger

Menu

Push the Trigger Menu button, and then push the Type bottom screen button to select Video. Choose video triggering to trigger on the odd fields, even fields, or on all the lines of an NTSC, PAL, or SECAM video signal. If installed, see the user manual for the TDS3VID Extended Video or the TDS3SDI 601 Digital Video application module for more information. The next table lists the menu items when the trigger Type is set to Video.

Bottom	Side	Description
Standard	525/NTSC	Triggers on a NTSC signal.
	625/PAL	Triggers on a PAL signal.
	SECAM	Triggers on a SECAM signal.

Bottom	Side	Description
Source	Ch1, Ch2 (Ch3, Ch4)	Sets the video signal source.
	Ext Ext/10	Sets external or external divided by 10 as the signal source.
	Ext Probe nnX Voltage / Current (4-channel only)	Set this value to match the attenuation factor and the type of probe (voltage or current) that is attached to the external trigger connector. Push the menu button to select the probe type. Use the general purpose knob to set the attenuation factor. The default values are 1x and voltage.
	AC Line	Sets the AC line frequency as the trigger source. This trigger source is only available when the oscilloscope is connected to AC power.
	Vert	Sets the lowest-numbered displayed channel as the trigger source.
	Alternating (all active channels)	Sequentially uses each active channel as a trigger source, from the lowest-numbered active channel to the highest-numbered active channel. (See page 114.)
Trigger On	Odd Even	Triggers on odd or even fields in an interlaced signal.
	All Fields	Triggers on any field in an interlaced or noninterlaced signal.
	All Lines	Triggers on all lines.
Mode & Holdoff		The table on Edge triggering includes a description of this menu item. (See page 113.)

Key Points

Displaying the Trigger Source. You do not have to display a channel to use it as a trigger source.

Sync Pulses. When you choose Video, the trigger always occurs on negative-going sync pulses. If your video signal has positive-going sync pulses, invert the signal using the Vertical menu. (See page 140.)

Utility

Utility

Push the Utility menu button, and the System Config bottom screen button to access submenus.

The following are examples of what you can do in the Utility menu:

- Use Config to select a language or set the time and date.
- Use Apps if an installed application module places items in this menu. See the documentation provided with your application modules for more information.
- Use I/O to set up the communication ports.
- Use Hard Copy to set up hard copy parameters. (See page 78, *Hard Copy*.)
- Use Cal to compensate the signal path.
- Use Diags to run internal diagnostic routines.

Configure System

Use the System Config menu to access these functions.

Bottom	Side	Description
System Config		
Language	English	Use to choose your native language. Most on-screen text appears in the language you choose.
	French	
	Italian	
	German	
	Spanish	
	Japanese	
	Brazilian Portuguese	
	Simplified Chinese	
	Traditional Chinese	
	Korean	
	Russian	

Bottom	Side	Description
Set Date & Time	Display Date/Time	Use to turn the date/time display On or Off.
	Hour Min	Use to set the internal clock with the current hour and minute.
	Month Day	Use to set the internal clock with the current month and day.
	Year	Use to set the internal clock with the current year.
	OK Enter Date/Time	Sets the date and time of the internal clock.
Battery Time-Outs	Power Off Time-Out	Use to set the time before an automatic shut down.
	Backlight Time-Out	Use to set the time before the backlight automatically turns off.
TekSecure Erase Memory		Erases all nonvolatile waveform and setup memory. For more information, refer to the <i>TDS3000C Series Digital Phosphor Oscilloscopes Declassification and Security Instructions</i> .
Version		Use to see the firmware version.

Key Points

Setting the Date and Time. To set the internal clock with the current date and time, push the Set Date & Time screen button. Use the general purpose knob to set the values after you push the screen buttons for the year, day and month, hour and minute. Push the OK Enter Date/Time screen button to complete the operation.

Power Off Time-Out. Use this feature to automatically turn the oscilloscope to standby if it is not being used. Use the general purpose knob to set the power off time-out delay to a fixed time or to ∞ (time-out off). Cycle the power switch to turn the oscilloscope back on after an automatic shut down.

Power off time-out operates only when you use battery power.

Backlight Time-Out. Push this button to adjust the backlight time-out delay. This feature automatically turns the backlight off after a period of time if the oscilloscope is not being used. Use the general purpose knob to set the backlight time-out delay to a fixed time or to ∞ (time-out off). Push any button to turn the backlight back on after an automatic time-out.

Backlight time-out operates only when you use battery power.

TekSecure. If you have acquired confidential data on your oscilloscope, you may want to execute the TekSecure function before you return the oscilloscope to general use. The TekSecure function does the following tasks:

- Replaces all waveforms in all reference memories with null sample values
- Replaces the current front-panel setup and all stored setups with the factory setup
- Calculates the checksums of all waveform memory and setup memory locations to verify successful completion of waveform and setup erasure
- Displays a confirmation or warning message if the checksum calculation is successful or unsuccessful

After you execute the TekSecure function, you must turn off the oscilloscope power and then turn the power back on to complete the process.

I/O System

Use the System I/O menu to access these functions.

Bottom	Side	Description
System I/O		
GPIB (TDS3GV)	Talk/Listen Address	Sets the GPIB address.
	Hard Copy (Talk Only)	Sets the GPIB port to talk only for making hard copies.
	Off Bus	Disables the GPIB port.
	Debug	Enables and disables a message window to help you debug GPIB problems.
RS-232 (TDS3GV)	Baud Rate	Sets the baud rate in steps from 1200 to 38400.
	Flagging	Use to enable hard flagging (RTS/CTS) or turn flagging off.
	EOL	Selects end-of-line terminator.
	Debug	Enables and disables a message window to help you debug RS-232 problems.
	Set RS-232 Parameters to Default Values	Sets baud rate = 9600, hard flagging = on, and EOL = LF.
Ethernet Network Settings	Change Instrument Settings DHCP/BOOTP	Displays a list of fields in which you set oscilloscope Ethernet parameters such as address, oscilloscope name, domain name, and so on. See Appendix F, <i>Ethernet Setup</i> , for information on setting the oscilloscope Ethernet network parameters.
	Debug	Enables and disables a message window to help you debug Ethernet problems.
	Test Connection	Tests the oscilloscope's Ethernet connection.

Bottom	Side	Description
Ethernet Printer Settings	Add Printer	Adds, renames, or deletes an Ethernet network printer from the oscilloscope printer list. See Appendix F, <i>Ethernet Setup</i> , for information on setting the oscilloscope Ethernet network printer parameters.
	Rename Printer	
	Delete Printer	
	Confirm Delete	Enables or disables displaying a confirmation message before deleting a printer from the oscilloscope printer list.

Key Points

More Information. Refer to the *TDS3000, TDS3000B and TDS3000C Series Digital Phosphor Oscilloscopes Programmer Manual* for more information about using the Ethernet, RS-232 and GPIB ports.

RS-232 Troubleshooting. If you are having difficulties with RS-232 communication, try the following remedies:

- Verify that you are using the correct RS-232 cable and adapters. Most computers require a null-modem connection to the oscilloscope. Most printers require a straight-through connection to the oscilloscope.
- Verify that the RS-232 cable is connected to the correct port on your computer or hard copy device.
- Reset the RS-232 parameters to defaults and then set the baud rate to match the computer or hard copy device. The default settings (except baud rate) are standard on most computers and hard copy devices.
- Enable the debug window to see the RS-232 status, errors, data transmitted, and data received.

GPIO Guidelines. Follow these guidelines when you connect your oscilloscope to a GPIO network:

- Turn off the oscilloscope and all external devices before connecting the oscilloscope to the GPIO network.
- Assign a unique device address to the oscilloscope. Two devices cannot share the same device address.
- Turn on at least two-thirds of the GPIO devices while using the network.

Calibration System

Use the System Cal menu to access these functions.

Bottom	Side	Description
System Cal		
Signal Path		Compensates the signal paths to obtain best measurement accuracy.
Factory Cal		Used to calibrate the oscilloscope. This is a service function only.
Cal Due Control	Notify After Hours of Operation	Sets the number of hours of operation before notifying you that a calibration is due.
	Notify After Years of Elapsed Time	Sets the number of years before notifying you that a calibration is due.

Key Points

Signal Path Compensation. For maximum accuracy at any time, run the SPC routine just before taking critical measurements. To meet accuracy specifications, run the routine if the ambient temperature changes by 10 °C (18 °F) or more.

Before running the routine, disconnect any probes or cables from the channel inputs. Then, push the Signal Path and the OK Compensate Signal Path screen buttons to confirm that you are ready to proceed. The routine takes several minutes to complete. (See page 4.)

Factory Cal. Service personnel use these functions to calibrate the oscilloscope internal voltage references using external sources. Refer to

your Tektronix field office or representative for assistance with these processes.

Cal Due Control. The calibration due notification occurs only in the power-on screen. Set the controls to ∞ if you do not want to be notified when calibration is due.

Diagnostic System

Use the System Diags menu to access these functions.

Bottom	Side	Description
System Diags		
Execute		Starts diagnostics.
Loop	Once	Executes the diagnostic loop once.
	Always	Executes the diagnostic loop continuously.
	Until Fail	Executes until a failure occurs.
Error Log	Page Up	Use to see the previous error log page.
	Page Down	Use to see the next error log page.

Key Points

Starting Diagnostics. To execute the built-in diagnostic routines, disconnect all cables or probes from the oscilloscope inputs, and then push the OK Run Test screen button.

Stopping Diagnostics. Choose how you want the diagnostic routines to execute:

- Loop Once runs all diagnostic routines one time and then stops.
- Loop Always runs the diagnostic routines continuously. Push the Run/Stop and then the Menu Off buttons to resume normal operation.
- Loop Until Fail runs the diagnostic routines until the oscilloscope fails a test or until you cycle the power.

Error Log. The error log contains summary data gathered over the life of the oscilloscope. The error log lists the last 100 errors encountered. The last error in the list is the most recent.

Under normal circumstances, the error log should be empty. Any entry in the error log may indicate a hardware failure or firmware fault. If you can repeatedly cause an entry to be added to the error log, please contact a Tektronix service representative for assistance.

Vertical Controls

You can use the vertical controls to select waveforms, adjust the waveform vertical position and scale, and set input parameters. All vertical operations affect the selected waveform. Push a channel button (1, 2, 3, or 4), the Math button, or the Ref button to select a waveform.

For information on the Math Menu, refer to the description on Math and FFT. (See page 86.)

Vertical Position Control



Use the vertical Position control to locate the selected waveform in the display. When you change the vertical position, a horizontal line temporarily appears to show you the ground reference level on the screen. After the line disappears, the ground reference level is marked at the left of the graticule.

If acquisition is stopped you can still reposition waveforms for analysis. The new position setting is used when acquisition resumes.

Waveform Off



Push the Waveform Off button to remove the selected waveform from the display. You can still use the channel as a trigger source.

Vertical Scale Control



Use the vertical Scale control to set the vertical scale factor of the selected waveform in 1-2-5 increments. If acquisition is stopped you can still rescale waveforms for analysis. The new scale setting is used when acquisition resumes.

You can also make fine adjustments to the vertical scale. (See page 140, *Channel Buttons*.)

Vertical Menu

Menu

Push the Vertical Menu button to show the Vertical menu of the selected waveform. (See page 140, *Channel Buttons*.) (See page 86, *Math and FFT*.) (See page 142, *Ref Button*.)

Channel Buttons

1

Push a channel button (1, 2, 3, or 4) to select a channel. Each channel button also displays the channel if it is not already displayed. Push the Vertical Menu button to show the Vertical menu of the selected channel. All vertical operations in the next table affect only the selected waveform.

Bottom	Side	Description
Coupling	DC	Sets input coupling to DC.
	AC	Sets input coupling to AC.
	GND	Provides a 0 V signal reference. The preamplifier disconnects from the input BNC. Input termination remains connected to the input BNC.
	Ω	Sets input resistance to 50 Ω or 1 M Ω , for DC or AC coupling.
Invert	Invert Off	Use for normal operation.
	Invert On	Inverts the polarity of the signal in the preamplifier.
Bandwidth	Full Bandwidth	Sets bandwidth to the full oscilloscope bandwidth.
	150 MHz	Sets the bandwidth to 150 MHz (not available on some models).
	20 MHz	Sets the bandwidth to 20 MHz.
Fine Scale	Fine Scale	Enables fine scale adjustment with the general purpose knob.
Position	Vertical Position	Enables numerical vertical position adjustment.
	Set to 0 divs	Sets vertical position to center screen.

Bottom	Side	Description
Offset	Vertical Offset	Enables vertical offset adjustment with the general purpose knob.
	Set to 0 V	Sets vertical offset to 0 V.
Probe Setup	Voltage Probe	Use to set probe gain or attenuation for probes that do not have the TekProbe II interface.
	Current Probe	
	Deskew	Use to adjust the time skew correction for each probe.
	Set to 0	Use to set probe skew correction to zero.

Key Points

Using Probes with the TekProbe II Interface. When you attach a probe with the TekProbe II interface, the oscilloscope sets the channel sensitivity, coupling, and termination resistance automatically to match the probe requirements.

Vertical Preview. When you change the Vertical Position or Scale controls while the acquisition is stopped or it is waiting for the next trigger, the oscilloscope rescales and repositions the selected waveform in response to the new vertical control settings. You may see a clipped waveform if the original acquisition went off the screen. The oscilloscope then uses the new settings for the next acquisition.

In contrast to horizontal preview, the math waveform, cursors, and automatic measurements remain active and valid when using vertical preview.

The Difference Between Vertical Position and Offset. Vertical position is a display function. Adjust the Vertical position to place the waveforms where you want to see them. The waveform baseline locations track adjustments made to their positions.

When you adjust vertical offset you see a similar effect, but it is actually quite different. Vertical offset is applied before the oscilloscope preamplifier and can be used to increase the effective dynamic range of the inputs. For example, you can use vertical offset to look at small variations in a large DC voltage. Set the Vertical offset to match the nominal DC voltage and the signal appears in the center of the screen.

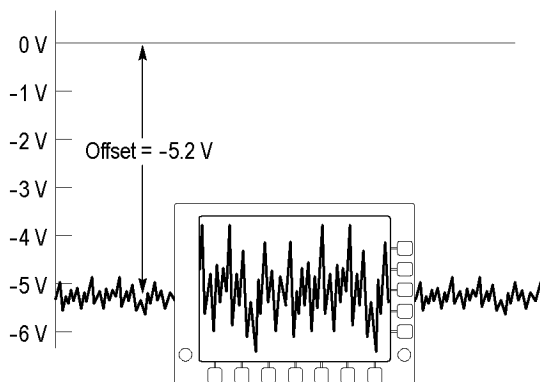

50 Ω Protection. If you select the 50 Ω termination resistance, the maximum vertical scale factor is limited to 1 V/div. If you apply excessive input voltage, the oscilloscope automatically switches to 1 M Ω termination resistance to protect the internal 50 Ω termination.

Ref Button

Ref

Push the Ref button to show the reference menu. Push one of the submenus to display a reference waveform or make it the selected reference waveform.

Bottom	Side	Description
Ref 1	Save Ch1 to Ref1	Saves channel 1 to Ref 1.
	Save Ch2 to Ref1	Saves channel 2 to Ref 1.
	Save Ch3 to Ref1	Saves channel 3 to Ref 1.
	Save Ch4 to Ref1	Saves channel 4 to Ref 1.
	Save Math to Ref1	Saves the math waveform to Ref 1.
Ref 2, Ref 3, Ref 4	Identical settings for the reference waveforms Ref 2, Ref 3, and Ref 4.	

Key Points

Selecting and Displaying Reference Waveforms. You can display all four reference waveforms at the same time. Push the submenu button to select a particular reference waveform. The selected waveform appears brighter than other displayed reference waveforms.

Removing Reference Waveforms from the Display. To remove a reference waveform from the display, select that reference waveform and then push the Waveform Off button .

Scaling and Positioning a Reference Waveform. You can position and scale a reference waveform independently from all other displayed waveforms. Select the reference waveform and then adjust it with a vertical or horizontal Position or Scale control. You can do this whether acquisition is running or is stopped.

If a reference waveform is selected, scaling and repositioning of the reference waveform operates the same way whether zoom is turned on or off.

Gray-Scale Restriction. Reference waveforms are always saved from the most current acquisition and do not contain any gray-scale information.

NOTE. *The TDS3AAM Advanced Analysis application module adds new math features, including arbitrary math expressions, DPO (gray scale) math waveforms, and FFT analysis.*

e*Scope Web-Based Remote Control

With e*Scope, you can access any Internet-connected TDS3000C series oscilloscope from a browser on your work station, PC, or laptop computer. No matter where you are, your TDS3000C oscilloscope is as close as the nearest browser.

There are two levels to e*Scope: basic and advanced. The basic level, which is hosted on the oscilloscope, lets you view a screen image of the current acquisition, save or load waveform and setup files, and send textual control and query commands to the oscilloscope.

The advanced level, which is hosted on your system, provides a graphical interface to view automatically updated screen images and to remotely control the oscilloscope. You can access the www.tektronix.com/software Web page and download the free advanced e*Scope Web-based Remote Control software.

Configuring Your Oscilloscope Ethernet Settings

Before using the e*Scope feature, you must set your oscilloscope Ethernet network settings. Appendix F, *Ethernet Setup*, describes how to enter the Ethernet network parameters for your oscilloscope.

Accessing e*Scope

After your oscilloscope is set up with the correct ethernet settings, you are ready to access that oscilloscope over the internet. To access the oscilloscope e*Scope server, follow these steps:

1. On a PC or work station, open your preferred browser program.
2. In the Location or Address field (where you normally enter a URL), type in the IP address of the TDS3000C oscilloscope to which you want to connect. For example, 188.121.212.107. Do not precede the IP address with any characters. Then push the Return key.
3. The browser program loads the oscilloscope's e*Scope home page, which is an image of the screen contents when your browser accessed the oscilloscope. The e*Scope home page will look something like the next image.
4. If you do not see the e*Scope home page after just a few moments, try the following:
 - a. Verify that the oscilloscope is physically connected to the network.
 - b. Verify that the oscilloscope network settings are correct.
 - c. Push the **Test Connection** side menu button in the Ethernet Network Settings menu to verify that the oscilloscope is electronically connected to the network.

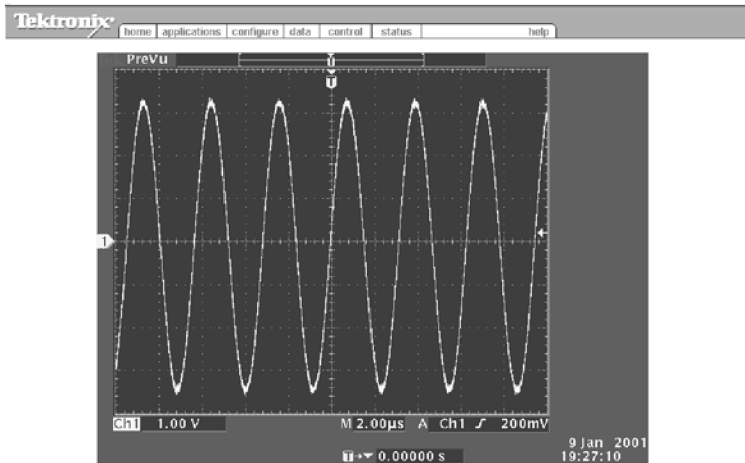

Basic e*Scope Menu Functions

The previous menu provides the following functions:

Home. Home displays the oscilloscope screen.

Applications. Applications takes you to the application URL specified in the Configure tab.

Configure. Configure lets you specify URLs for the advanced Web-based Control HTML pages (accessed from the Control menu).

Data. Data provides the basic level of e*Scope control. It lets you upload or download waveform data files and oscilloscope settings, as well as remotely control the oscilloscope using oscilloscope programming commands listed in the *TDS3000, TDS3000B and TDS3000C Series Digital Phosphor Oscilloscope Programmer Manual*.

Status. Status displays the version screen, which shows the firmware version and lists installed application modules.

Control. Control displays the advanced e*Scope Web-based Remote Control screen that lets you remotely control the oscilloscope using a graphical interface that includes on-screen interactive menus and

selectable controls for all front-panel buttons and knobs. You must download the free advanced e*Scope software from the Tektronix Web site.

Help. Help takes you to the TDS3000 series frequently asked questions page at www.tektronix.com.

NOTE. *You can create your own local Applications and Help files and access them by changing the Application and Help field in the Configure menu to point to your local web site containing your files.*

Application Examples

The following are some possible e*Scope usage examples:

Prototype Development. An engineering lab contains prototype boards that need evaluation. An engineer in the building can use e*Scope to access and remotely control a TDS3000C series oscilloscope to capture and download waveform data to a PC for analysis and inclusion in development reports.

Field Service Support. A company's central engineering department needs to support many field service technicians who maintain and repair installed systems located throughout the world. The field technicians can connect their TDS3000C series oscilloscopes to the systems, and the engineers can then use e*Scope to help the field technicians diagnose difficult problems.

Remote Line Down Troubleshooting. A production line is down in Korea. The chief engineer in the United States can use e*Scope to remotely control a TDS3000C series oscilloscope and view the waveforms to troubleshoot the problem, while having a technician at the production site probe the oscilloscope.

Remote Broadcast Transmitter Monitoring. A television station needs to monitor various voltages and waveforms at a remote transmitter site. An engineer at the transmitter can connect the TDS3000C series oscilloscope to the station's LAN and then connect the oscilloscope to the appropriate test points. The television station engineer can then use e*Scope to remotely monitor the voltages and waveforms.

Remote Development. Several engineers on a project need to access waveform and measurement data from a number of remote sites. Using e*Scope, the engineers can capture screen hard copies and waveform data from these remote sites and store the information in a central database.

Appendix A: Specifications

This appendix contains specifications for the TDS3000C Series oscilloscopes. All specifications are guaranteed unless noted as "typical." Typical specifications are provided for your convenience but are not guaranteed. Specifications that are marked with the ✓ symbol are checked in the *TDS3000C Specifications and Performance Verification Technical Reference* available on the www.tektronix.com/manuals Web site.

All specifications apply to all TDS3000C Series models unless noted otherwise. To meet specifications, two conditions must first be met:

- The oscilloscope must have been operating continuously for twenty minutes within the operating temperature range specified.
- You must perform the Signal Path Compensation operation. (See page 4, *Signal Path Compensation (SPC)*.) If the operating temperature changes by more than 10 °C (18 °F), you must perform the Signal Path Compensation operation again.

Acquisition

Acquisition modes	Sample (Normal), Peak detect, Envelope, and Average	
Single Sequence	<i>Acquisition mode</i>	<i>Acquisition stops after</i>
	Sample, Peak Detect	One acquisition, all channels simultaneously
	Average, Envelope	N acquisitions, all channels simultaneously, N is settable from 2 to 256 (or ∞ for Envelope)

Inputs

Input coupling	DC, AC, or GND Channel input remains terminated when using GND coupling.
Input impedance, DC coupled	1 M Ω \pm 1% in parallel with 13 pF \pm 2 pF, TekProbe compatible 50 Ω \pm 1% VSWR \leq 1.5:1 from DC to 500 MHz, V/div settings \geq 100 mV, typical VSWR \leq 1.6:1 from DC to 500 MHz, V/div settings < 100 mV, typical
Maximum voltage at input BNC (1 M Ω)	<i>Overvoltage category</i> <i>Maximum voltage</i>
	CAT I Environment ¹ 150 V _{RMS} (400 V _{pk} , Duty Factor of 37.5%)
	CAT II Environment ¹ 100 V _{RMS} (400 V _{pk} , Duty Factor of 25%)
	For steady-state sinusoidal waveforms, derate at 20 dB/decade above 200 kHz to 13 V _{pk} at 3 MHz and above.
Maximum voltage at input BNC (50 Ω)	5 V _{RMS} with peaks \leq \pm 30 V
Maximum floating voltage	0 V from chassis (BNC) ground to earth ground, or 30 V _{RMS} (42 V _{pk}) only under these conditions: no signal voltages >30 V _{RMS} (>42 V _{pk}), all common leads connected to the same voltage, no grounded peripherals attached
Channel to channel crosstalk, typical	Measured on one channel, with test signal applied to another channel, and with the same scale and coupling settings on each channel
	<i>Frequency range</i> <i>Crosstalk</i>
	\leq 100 MHz \geq 100:1
	\leq 300 MHz \geq 50:1
	\leq 500 MHz \geq 30:1
Differential delay, typical	100 ps between any two channels with the same scale and coupling settings

¹ For definitions, refer to the *Certifications and Compliances* information at the end of this appendix.

Vertical

Number of channels	<i>TDS30x2C</i>	<i>TDS30x4C</i>		
	2 plus external trigger input	4 plus external trigger input		
Digitizers	9-bit resolution, separate digitizers for each channel, sampled simultaneously			
Scale	1 M Ω	50 Ω		
Range (at BNC)	1 mV/div to 10 V/div	1mV/div to 1 V/div		
Fine Scale	Adjustable with $\geq 1\%$ resolution			
Polarity	Normal and Invert			
Position range	± 5 divisions			
✓ Analog bandwidth, 50 Ω (also typical at 1 M Ω with standard probe)	Bandwidth limit set to Full, operating ambient ≤ 30 °C, derate 1%/°C above 30 °C			
	<i>Scale range</i>	TDS301xC	TDS303xC	TDS305xC
	<i>10 mV/div to 1 V/div</i>	100 MHz	300 MHz	500 MHz
	<i>5 mV/div to 9.98 mV/div</i>	100 MHz	300 MHz	400 MHz
	<i>2 mV/div to 4.98 mV/div</i>	100 MHz	250 MHz	250 MHz
	<i>1 mV/div to 1.99 mV/div</i>	90 MHz	150 MHz	150 MHz
Calculated rise time, typical	TDS301xC	3.5 ns		
	TDS303xC	1.2 ns		
	TDS305xC	0.7 ns		
Analog bandwidth limit, typical	Selectable between 20 MHz, 150 MHz (not available on TDS3012C or TDS3014C), or Full			
Lower frequency limit, AC coupled, typical	7 Hz for 1 M Ω , reduced by a factor of ten when using a 10X passive probe; 140 kHz for 50 Ω			

Vertical

Peak detect or Envelope pulse response, typical	Minimum width of pulse with amplitude of ≥ 2 div to capture 50% or greater amplitude	
	<i>Sample rates ≤ 125 MS/s</i>	<i>Sample rates ≥ 250 MS/s</i>
	1 ns	1/sample rate
DC gain accuracy	$\pm 2\%$, derated at $0.025\%/^{\circ}\text{C}$ for temperatures above $+30^{\circ}\text{C}$, in Sample or Average acquisition mode	
DC measurement accuracy,	<i>Measurement type</i>	<i>DC Accuracy (in volts)</i>
Sample acquisition mode, typical	Absolute measurement of any waveform point	$\pm [0.02^1 \times \text{reading} - (\text{offset} - \text{position}) + \text{offset accuracy} + 0.15 \text{ div} + 0.6 \text{ mV}]$
	Delta voltage between any two points on a waveform	$\pm [0.02^1 \times \text{reading} + 0.15 \text{ div} + 1.2 \text{ mV}]$
DC measurement accuracy,	<i>Measurement type</i>	<i>DC Accuracy (in volts)</i>
✓ Average acquisition mode (≥ 16 averages)	Absolute measurement of any waveform point	$\pm [0.02^1 \times \text{reading} - (\text{offset} - \text{position}) + \text{offset accuracy} + 0.1 \text{ div}]$
	Delta voltage between any two points on a waveform	$\pm [0.02^1 \times \text{reading} + 0.05 \text{ div}]$
Offset range	<i>Scale range</i>	<i>Offset range</i>
	1 mV/div to 9.95 mV/div	$\pm 100 \text{ mV}$
	10 mV/div to 99.5 mV/div	$\pm 1 \text{ V}$
	100 mV/div to 995 mV/div	$\pm 10 \text{ V}$
	1 V/div to 10 V/div	$\pm 100 \text{ V}$
Offset Accuracy, all ranges	$\pm [0.005 \text{offset} - \text{position} + 0.1 \text{ div}]$ Note: Convert both the constant offset and position terms to volts by multiplying by the volts/div setting.	

¹ 0.02 term (gain component) derated at $0.0025\%/^{\circ}\text{C}$ above 30°C .

Horizontal

Acquisition (horizontal) resolution	<i>Normal</i> (10k point record)		<i>Fast trigger</i> (500 point record)
Maximum acq rate, typical	700 wfms/s		3,400 wfms/s
Sample rate range	<i>TDS301xC</i>	<i>TDS303xC</i>	<i>TDS305xC</i>
Normal	100 S/s to 1.25 GS/s	100 S/s to 2.5 GS/s	100 S/s to 5 GS/s
Fast trigger	5 S/s to 1.25 GS/s	5 S/s to 2.5 GS/s	5 S/s to 5 GS/s
Seconds/division range	4 ns/div to 10 s/div	2 ns/div to 10 s/div	1 ns/div to 10 s/div
✓ Sample rate and delay time accuracy	±20 ppm over any ≥1 ms time interval		

Trigger

External trigger input impedance, typical	TDS30x2C: 1 M Ω in parallel with 17 pF, TekProbe compatible TDS30x4C: 1 M Ω in parallel with 52 pF, not TekProbe compatible	
External trigger maximum voltage	<i>Overvoltage category</i>	<i>Maximum voltage</i>
	CAT I Environment ¹	150 V _{RMS} (400 V _{pk} , Duty Factor of 37.5%)
	CAT II Environment ¹	100 V _{RMS} (400 V _{pk} , Duty Factor of 25%)
	For steady-state sinusoidal waveforms, derate at 20 dB/decade above 200 kHz to 13 V _{pk} at 3 MHz and above.	
External trigger maximum floating voltage	0 V from chassis (BNC) ground to earth ground, or 30 V _{RMS} (42 V _{pk}) only under these conditions: no signal voltages >30 V _{RMS} (>42 V _{pk}), all common leads connected to the same voltage, no grounded peripherals attached	

Trigger

	<i>Source</i>	<i>Sensitivity</i>
✓ Edge trigger sensitivity	Any channel, DC coupled	≤ 0.6 div from DC to 50 MHz, increasing to 1 div at oscilloscope bandwidth
Edge trigger sensitivity, typical	External trigger	200 mV from DC to 50 MHz, increasing to 750 mV at 300 MHz
	External/10 trigger	500 mV from DC to 50 MHz, increasing to 3 V at 300 MHz
	Any channel, NOISE REJ coupled	3.5 times the DC-coupled limits
	Any channel, HF REJ coupled	1.5 times the DC-coupled limit from DC to 30 kHz, attenuates signals above 30 kHz
	Any channel, LF REJ coupled	1.5 times the DC-coupled limits for frequencies above 80 kHz, attenuates signals below 80 kHz
Trigger level range	<i>Source</i>	<i>Sensitivity</i>
	Any channel	±8 divisions from center of screen, ±8 divisions from 0 V if LF REJ trigger coupled
	External trigger	±800 mV
	External/10 trigger	±8 V
	Line	Fixed at the midlevel of the AC line
SET Level TO 50%, typical	Operates with input signals ≥45 Hz	

Trigger

Trigger level accuracy, typical	<i>Source, DC coupled</i>			<i>Sensitivity</i>
	Any channel			± 0.2 divisions
	External trigger			± 20 mV
	External/10 trigger			± 200 mV
	Line			N/A
Trigger holdoff range	250.8 ns to 10 s			
Logic and Pulse Trigger Sensitivity, typical	1.0 division at BNC, DC Coupled, ≥ 10 mV/div to ≤ 1 V/div (pattern, state, delay, width, and runt triggering)			
Slew Rate Trigger Sensitivity, typical	Same as the Edge Trigger Sensitivity specifications shown earlier in this appendix.			
Logic Triggering Minimum Logic Time, typical	<i>State</i>	<i>Pattern</i>	<i>Pattern with pulse width</i>	
	2 ns	2 ns	5 ns	
	State minimum logic time: the time that a logic state must be valid before and after the clock edge to be recognized. Pattern minimum logic time: the time that a logic pattern must be valid to be recognized. Pattern with pulse width qualification, minimum logic time: the time that a logic pattern must be valid to be recognized.			
Logic Triggering Minimum Rarm Time, typical	<i>State</i>	<i>Pattern</i>	<i>Pattern with pulse width</i>	
	4 ns ²	2 ns	5 ns	
	State minimum rearm time: the time between consecutive clocks. Pattern minimum rearm time: the time that a logic pattern must be invalid before a new occurrence of the pattern will be recognized. Pattern with pulse width qualification, minimum rearm time: the time that a logic pattern must be invalid before a new occurrence of the pattern will be recognized.			

Trigger

Pulse	5 ns	
Triggering	For width and runt, minimum pulse width refers to the pulse being measured. For slew rate, minimum pulse width means the minimum delta time that the oscilloscope recognizes.	
Minimum Pulse Width, typical		
Pulse	5 ns	
Triggering	For width and runt, rearm time refers to the time between measured pulses. For slew rate, rearm time refers to the time it takes the signal to recross the two signal thresholds.	
Minimum Rearm Time, typical		
Delta Time Resolution using general purpose knob	<i>Time Range</i>	<i>Resolution</i>
	39.6 ns to 9.99 μ s	13.2 ns
	10 μ s to 99.9 μ s	92.4 ns
	100 μ s to 999 μ s	1 μ s
	1 ms to 9.99 ms	10 μ s
	10 ms to 99.9 ms	100 μ s
	100 ms to 999 ms	1 ms
	1 s to 10 s	10 ms
Video trigger sensitivity, typical	Triggers on negative sync of NTSC, PAL, or SECAM signal	
	<i>Source</i>	<i>Sensitivity</i>
	Any channel	0.6 to 2.5 divisions of video sync tip
	External trigger	150 mV to 625 mV of video sync tip
	External/10 trigger	1.5 V to 6.25 V of video sync tip
B Trigger Range	<i>Trigger After Time</i>	<i>Trigger After B Events</i>
	13.2 ns to 50 s	1 event to 9,999,999 events

Trigger

Minimum time between arm and trigger, typical	5 ns from the end of the time period and the B trigger event	5 ns between the A trigger event and the first B trigger event
Minimum Pulse Width, typical	—	B event width: 4 ns for TDS301xC 2 ns for TDS303xC, TDS305xC
Maximum Frequency, typical	—	B event frequency: 100 MHz for TDS301xC 250 MHz for TDS303xC, TDS305xC

- ¹ For definitions, refer to the *Certifications and Compliances* information at the end of this appendix.
- ² Minimum logic time is 4 ns or $(1 \div \text{input channel bandwidth})$, whichever is larger.

Display

Display screen	6.5 in (165 mm) diagonal color liquid crystal
Display resolution	640 horizontal by 480 vertical pixels
Backlight intensity, typical	200 cd/m ²
Display color	Up to 16 colors, fixed palette
External display filter	Scratch-resistant tempered glass

I/O Ports

Ethernet port	10BaseT RJ-45 female connector (all models)
GPIB interface	Available in optional accessory TDS3GV
RS-232 interface	DB-9 male connector, available in optional accessory TDS3GV
USB flash drive port	USB flash drive connector (all models)
VGA signal output	DB-15 female connector, 31.6 kHz sync rate, EIA RS-343A compliant, available in optional accessory TDS3GV
Probe compensator output, typical	5.0 V into $\geq 1 \text{ M}\Omega$ load, Frequency = 1 kHz

Miscellaneous

Nonvolatile memory	Typical retention time ≥ 5 years for front-panel settings, unlimited for saved waveforms and setups
Internal clock	Provides date/time stamp for stored data and the current time and date to the front panel, if enabled.

Power source

AC line power	Operates the oscilloscope and charges the optional internal battery
Source voltage	$100 \text{ V}_{\text{RMS}}$ to $240 \text{ V}_{\text{RMS}} \pm 10\%$, continuous range
Source frequency	47 Hz to 440 Hz
Power consumption	75 W maximum
Battery power	Optional accessory TDS3BATC, rechargeable Li-Ion battery pack
Operating time, typical	3 hours, depending on operating conditions
Battery charge time, typical	32 hours in the oscilloscope, 6 hours in the optional external charger TDS3CHG
Line fuse	Internal, not replaceable

Environmental

Temperature	Operating range: +0 °C to +50 °C (+32 °F to +122 °F) Nonoperating range (storage): -40 °C to +71 °C (-40 °F to +160 °F)
Humidity	5% to 95% RH below 30 °C (+86 °F), derate upper limit to 45% RH at 50 °C (+122 °F)
Pollution Degree	Pollution Degree 2: indoor use only
Altitude	Operating limit: 3000 m (3,280 yd.) Nonoperating limit: 15,000 m (16,404 yd.)
Random vibration	Operating: 0.31 g _{RMS} from 5 Hz to 500 Hz, 10 minutes on each axis Nonoperating: 2.46 g _{RMS} from 5 Hz to 500 Hz, 10 minutes on each axis

Mechanical

Size	Height: 176 mm (6.9 in), 229 mm (9.0 in) including handle Width: 375 mm (14.75 in) Depth: 149 mm (5.9 in)
Weight	Oscilloscope only: 3.2 kg (7.0 lbs) With accessories and carry case: 4.1 kg (9.0 lbs) When packaged for domestic shipment: 5.5 kg (12.0 lbs) Optional TDS3BATC battery pack: 0.85 kg (1.9 lbs)

Certifications and Compliances

EC Declaration of Conformity – EMC

Meets intent of Directive 2004/108/EEC for Electromagnetic Compatibility. Compliance was demonstrated to the following specifications as listed in the Official Journal of the European Communities:

EN 61326:1997. EMC requirements for Class A electrical equipment for measurement, control, and laboratory use. Annex D. ^{1 2 3}

- IEC 61000-4-2:1999. Electrostatic discharge immunity
- IEC 61000-4-3:2002. RF electromagnetic field immunity ^{4 5}
- IEC 61000-4-4:2004. Electrical fast transient/burst immunity
- IEC 61000-4-5:2005. Power line surge immunity
- IEC 61000-4-6:2003. Conducted RF immunity
- IEC 61000-4-11:2004. Voltage dips and interruptions immunity

EN 61000-3-2:2000. AC power line harmonic emissions

EN 61000-3-3:1995. Voltage changes, fluctuations, and flicker

European Contact.

Tektronix UK, Ltd.
Western Peninsula
Western Road
Bracknell, RG12 1RF
United Kingdom

- 1 This product is intended for use in nonresidential areas only. Use in residential areas may cause electromagnetic interference.
- 2 Emissions which exceed the levels required by this standard may occur when this equipment is connected to a test object.
- 3 To ensure compliance with the EMC standards listed here, high quality shielded interface cables should be used. High quality shielded cables typically are braid and foil types that have low impedance connections to shielded connectors at both ends.
- 4 The increase in trace noise while subjected to a test field (3 V/m over the frequency range 80 MHz to 1 GHz, with 80% amplitude modulation at 1 kHz) is not to exceed 8 major

divisions peak-to-peak. Ambient conducted fields may induce triggering when the trigger threshold is offset less than 4 major divisions from ground reference.

- 5 The increase in trace noise while subjected to a test field (3 V/m over the frequency range 150 kHz to 80 MHz, with 80% amplitude modulation at 1 kHz) is not to exceed 2 major divisions peak-to-peak. Ambient conducted fields may induce triggering when the trigger threshold is offset less than 1 major divisions from ground reference.

Australia / New Zealand Declaration of Conformity – EMC

Complies with the EMC provision of the Radiocommunications Act per the following standard, in accordance with ACMA:

- EN 61326:1997. EMC requirements for electrical equipment for measurement, control, and laboratory use.

FCC – EMC

Emissions are within the limits of FCC 47 CFR, Part 15, Subpart B for Class A equipment.

EC Declaration of Conformity – Low Voltage

Compliance was demonstrated to the following specification as listed in the Official Journal of the European Communities:

Low Voltage Directive 2006/96/EC.

- EN 61010-1: 2001. Safety requirements for electrical equipment for measurement control and laboratory use.

U.S. Nationally Recognized Testing Laboratory Listing

- UL 61010-1: 2004, 2nd Edition. Standard for electrical measuring and test equipment.

Canadian Certification

- CAN/CSA C22.2 No. 61010-1:2004. Safety requirements for electrical equipment for measurement, control, and laboratory use. Part 1.

Additional Compliances

- IEC 61010-1: 2001. Safety requirements for electrical equipment for measurement, control, and laboratory use.

Equipment Type

Test and measuring equipment.

Safety Class

Class 1 – grounded product.

Pollution Degree Description

A measure of the contaminants that could occur in the environment around and within a product. Typically the internal environment inside a product is considered to be the same as the external. Products should be used only in the environment for which they are rated.

- Pollution Degree 1. No pollution or only dry, nonconductive pollution occurs. Products in this category are generally encapsulated, hermetically sealed, or located in clean rooms.
- Pollution Degree 2. Normally only dry, nonconductive pollution occurs. Occasionally a temporary conductivity that is caused by condensation must be expected. This location is a typical office/home environment. Temporary condensation occurs only when the product is out of service.
- Pollution Degree 3. Conductive pollution, or dry, nonconductive pollution that becomes conductive due to condensation. These are sheltered locations where neither temperature nor humidity is controlled. The area is protected from direct sunshine, rain, or direct wind.
- Pollution Degree 4. Pollution that generates persistent conductivity through conductive dust, rain, or snow. Typical outdoor locations.

Pollution Degree

Pollution Degree 2 (as defined in IEC 61010-1). Note: Rated for indoor use only.

Installation (Overvoltage) Category Descriptions

Terminals on this product may have different installation (overvoltage) category designations. The installation categories are:

- Measurement Category IV. For measurements performed at the source of low-voltage installation.
- Measurement Category III. For measurements performed in the building installation.
- Measurement Category II. For measurements performed on circuits directly connected to the low-voltage installation.
- Measurement Category I. For measurements performed on circuits not directly connected to MAINS.

Overvoltage Category

Overvoltage Category II (as defined in IEC 61010-1)

Appendix B: Factory Setup

The next table lists the state of the oscilloscope after you recall the Factory Setup.

Control	Changed by factory setup to
Acquire horizontal resolution	Normal (10k points)
Acquire mode	Sample
Acquire number of averages	16
Acquire number of envelopes	16
Acquire run/stop	Run
Acquire single sequence	Off
Acquire WaveAlert actions all	Off
Acquire WaveAlert sensitivity	50%
Acquire WaveAlert state	Off
Acquire WaveAlert type	Highlight entire waveform
Channel selection	Ch1 (all others off)
Coarse	No change
Confirm delete	No change
Cursor function	Off
Cursor H Bar 1 position	-3.2 divisions from the center
Cursor H Bar 2 position	+3.2 divisions from the center
Cursor H Bar units	Base
Cursor V Bar 1 position	10% of record
Cursor V Bar 2 position	90% of record
Cursor V Bar units	Seconds
Cursor tracking	Independent
Delay measure from waveform edge	Rising
Delay measure to edge occurrence	First
Delay measure to waveform	Ch1
Delay measure to waveform edge	Rising
Display graticule type	Full

Control	Changed by factory setup to
Display backlight	High
Display color palette	Normal
Display dots only	Off
Display persist time	Auto
Dual waveform math function	Ch1 + Ch2
Edge trigger coupling	DC
Edge trigger level	0.0 V
Edge trigger slope	Rising
Edge trigger source	Ch1
External trigger probe setup (four-channel models only)	Voltage, 1X
Horizontal delay	On
Horizontal delay time	0 ns
Horizontal trigger position	10%
Horizontal time/div	400 ms/div
Horizontal zoom	Off
Horizontal zoom position	50%
Horizontal zoom time/div	400 ms/div
Math type	Dual waveform
Measure gating	Off (Full Record)
Measure high-low setup	Auto
Measure high reference	90% and 0 V
Measure indicators	Off
Measure low reference	10% and 0 V
Measure mid reference	50% and 0 V
Measure mid2 reference	50% and 0 V
Measure statistics	Off
Overwrite lock	No change
Phase measure to waveform	Ch1
Reference waveforms	No change

Control	Changed by factory setup to
Saved setups	No change
Trigger holdoff	250.8 ns
Trigger mode	Auto
Trigger type	Edge
Utility language	No change
Utility date/time display	On
Utility I/O	No change
Utility hard copy	No change
Vertical bandwidth	Full
Vertical coupling	DC 1 M Ω
Vertical invert	Off
Vertical offset	0 V
Vertical position	0 div
Vertical probe setup	Voltage, 1 X (unless a non-1 X probe is attached)
Vertical volts/div	100 mV/div
Video trigger standard	525/NTSC
Video trigger on	All lines
Waveform file format	No change
XY display	Off

Appendix C: Accessories

The next table lists the standard accessories.

P6139A 10X passive probes (TDS303xC, TDS305xC)

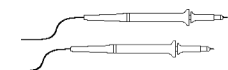

The P6139A 10X passive probes have 300 MHz or 500 MHz bandwidth and a CAT II voltage rating of 300 V_{RMS}.

Front cover

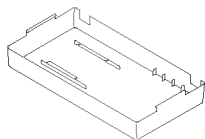

The front cover (200-4416-01) snaps onto the front of the oscilloscope to protect it during transit. The front cover contains a convenient location to store the Reference manual.

Accessory tray

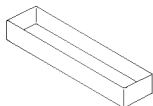

The accessory tray (436-0371-00) fits in the battery compartment when you do not have a battery installed. You can use the tray to store probes and other accessories.

PC communications CD-ROM

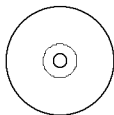

The PC communications software provides easy transfer of data from the oscilloscope to a PC.

Manuals



The oscilloscope includes a printed User manual. All TDS3000C product and optional accessory user manuals, in all supported languages, are available to download from the www.tektronix.com/manuals Web page.

The next table lists the optional accessories.

TDS3VID Extended Video application module



This module adds video trigger, video picture, vectorscope (vectorscope supports component video only), analog HDTV triggering, and measurement capabilities to your oscilloscope.

TDS3TMT Telecom Mask Test application module



This module adds ITU-T G.703, ANSI T1.102 (up to DS3 data rates), and custom mask testing capabilities to your oscilloscope.

TDS3SDI 601 Digital Video application module

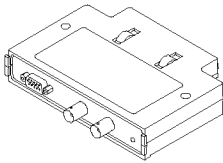

This module adds 601 serial digital video to analog video conversion, video picture, vectorscope, and analog HDTV triggering capabilities to your oscilloscope.

TDS3AAM Advanced Analysis application module



This module adds advanced math capabilities to your oscilloscope, including DPO math, arbitrary math expression waveforms, new measurements, and measurement statistics.

TDS3LIM Limit Test application module



This module adds custom waveform limit testing capabilities to your oscilloscope.

TDS3GV GPIB/RS-232/VGA communication module

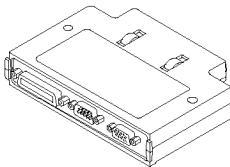

This module adds RS-232, GPIB, and VGA ports for remote programmability or to display the oscilloscope screen on a monitor.

TDS3CHG external battery charger

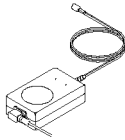

The battery charger recharges the oscilloscope battery pack in approximately 6 hours.

TDS3BATC rechargeable battery pack

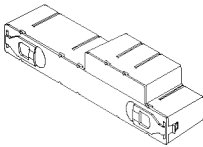

A rechargeable battery pack that provides up to three hours of portable operation.

AC3000 soft case

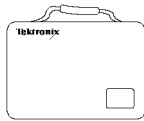

The soft case protects the oscilloscope when not in use. The soft case provides compartments for probes, one spare battery, battery charger, and the User Manual.

HCTEK4321 transit case

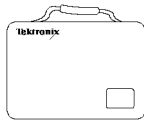

The transit case provides shock, vibration, impact, and moisture protection for the oscilloscope when you transport it from one place to another, or when you store it. The required soft case fits inside the transit case.

RM3000 rack mount kit

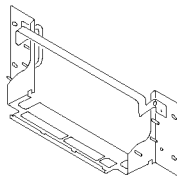

The rack mount kit contains all the hardware necessary to mount your oscilloscope in a standard rack. The kit requires 7 inches of vertical space in the rack.

Manuals



The service manual (071-2507-XX) provides information about maintenance and module-level repair.

The programmer manual (071-0381-XX) provides information and a list of the oscilloscope control and query commands.

Appendix D: Probe Basics

This appendix contains basic information about the P3010 or P6139A probes provided with your oscilloscope. It also contains information about other probes you can use with your oscilloscope and their limitations.

Probe Descriptions

The P3010 and P6139A are high-impedance passive probes with the following general characteristics.

Characteristic	P3010	P6139A
Cable length	2 m	1.3 m
Compatibility	100 MHz oscilloscope models	300 MHz and 500 MHz oscilloscope models
Bandwidth	100 MHz	500 MHz
Attenuation	10X	10X
Nominal input impedance	10 M Ω in parallel with 13 pF	10 M Ω in parallel with 8 pF
Maximum working voltage	300 V, CAT II, derated at 20 dB/decade to 50 V above 2.5 MHz	300 V, CAT II, derated at 20 dB/decade to 50 V above 2.5 MHz
Altitude	3,000 m	2,000 m
Temperature Range		
Operating	-15 °C to +55 °C (+5 °F to +131 °F)	-15 °C to +65 °C (+5 °F to +149 °F)
Non Operating	-62 °C to +85 °C (-80 °F to +185 °F)	-62 °C to +85 °C (-80 °F to +185 °F)
Pollution Degree	2, Indoor use only	2, Indoor use only

Probe Compensation

You should compensate a probe to an oscilloscope input whenever you attach a probe for the first time to any input channel. (See page 3, *Probe Compensation*.)

When compensating the P3010, only adjust the trimmer marked L.

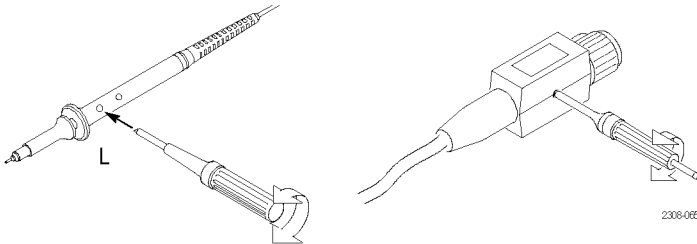

TekProbe Interface

Probes with the TekProbe interface automatically communicate with the oscilloscope to set the probe type and attenuation factor. If you use a probe without the TekProbe interface, you can set these parameters in the Vertical menu for the channel that the probe is connected to.

Probe Guard

A guard around the probe body provides a finger barrier for protection from electric shock.

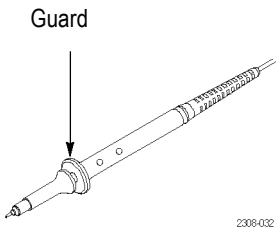



WARNING. To avoid electric shock when using the probe, keep fingers behind the guard on the probe body.

To avoid electric shock when using the probe, do not touch metallic portions of the probe head while connected to a voltage source.

Ground Leads

Always use a ground lead when you probe a circuit to minimize noise pickup and signal aberrations. Connecting the ground lead to a point near the signal source usually provides the best results.

Long ground leads can cause false ringing and aberrations in the acquired waveform that are not in the actual signal. To see the best signal fidelity, use the shortest possible ground lead.

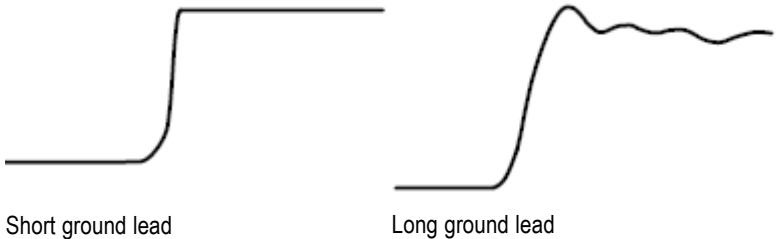

P3010 High-Frequency Compensation

The P3010 high-frequency compensation should seldom require adjustment. However, your probe may require high-frequency adjustment if either of the following are true:

- The probe has high-frequency aberrations
- The probe does not perform at the rated bandwidth

To perform the high-frequency compensation adjustment, you will need a signal source that has all of the following characteristics:

- Square-wave output at 1 MHz
- Fast rise output with rise time less than 1 ns
- Output properly terminated

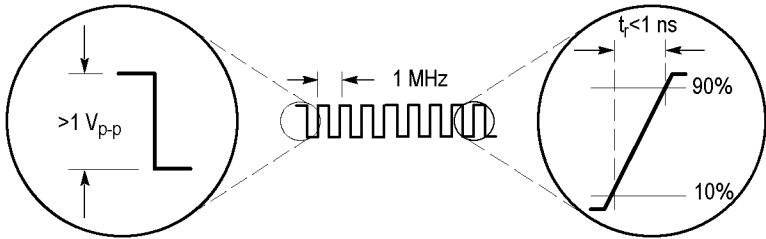

Connect the P3010 to the signal source to display a 1 MHz test signal on your oscilloscope. Use the BNC-to-probe tip adapter (013-0277-00) to make the connection. The oscilloscope should display a waveform similar to the one shown next.

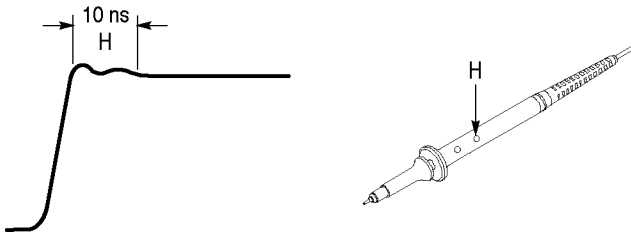

Adjust trimmer H until the waveform is flat on top and has a square leading edge.

P3010 Replaceable Parts and Accessories

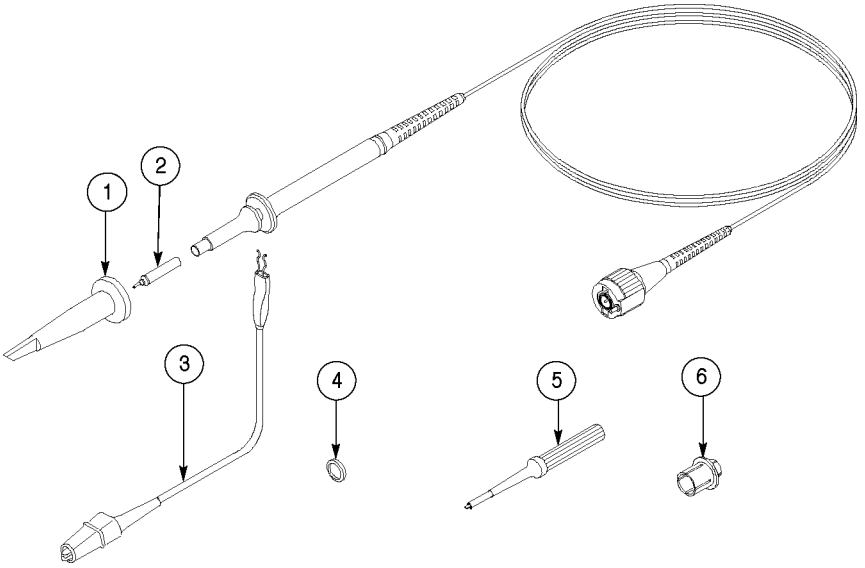

Standard Accessories

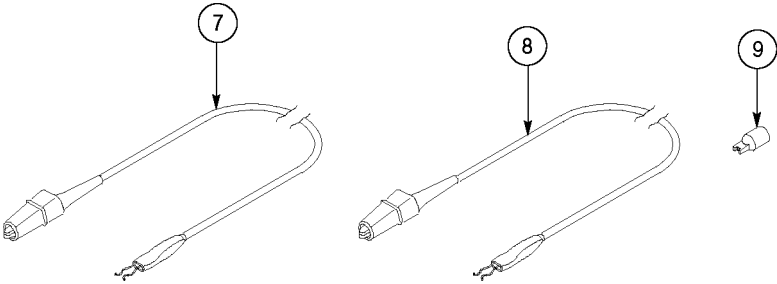

Optional Accessories

Index	Description	Part
1	Retractable hook tip	013-0107-08
2	Probe tip	131-4997-01
3	Ground lead, 6 in	196-3120-01
4	Marker set (five colors, two each)	016-0633-00
5	Adjustment tool	003-1433-01
6	BNC-to-probe tip adapter	013-0277-00
7	Ground lead, 28 in	196-3120-21
8	Ground lead, 12 in	196-3121-01
9	IC test tip, package of 10	015-0201-07

P6139A Replaceable Parts and Accessories

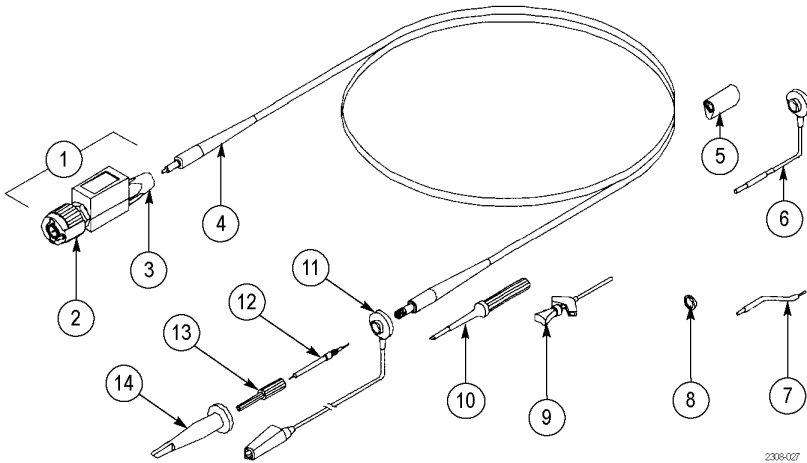

2308-027

Standard Accessories

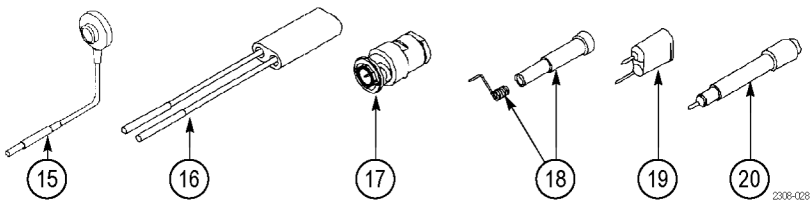

Optional Accessories

Index	Description	Part
1	Compensation box assembly	206-0440-04
2	BNC connector	131-3219-03
3	Cable cover nipple	200-3018-00
4	Cable assembly	174-0978-02
5	Ground collar	343-1003-02
6	Ground lead, 6 in	196-3113-04
7	Ground lead, 2.3 in	195-4240-00
8	Marker set (five colors, two each)	016-0633-00
9	IC Klipchip grabber	206-0569-00
10	Adjustment tool	003-1433-02
11	Ground lead with clip, 6 in	196-3305-01
12	Probe tip assembly	206-0441-00
13	Probe tip cover	204-1049-00
14	Retractable hook tip	013-0107-08
Optional accessories		
15	Ground lead, 3 in	196-3113-04
16	Probe to connector pin adapter	015-0325-01
17	50 Ω BNC-to-probe tip termination and adapter	013-0227-00
18	Ground contact kit (two each of five lengths) with cover shell	016-1077-00
19	Grounding probe tip	013-0085-00
20	Adapter to use with the grounding probe tip, or with the probe to connector pin adapter	013-0202-04

Using Other Probes

Optional probes can add capabilities to your oscilloscope that are useful in many applications. You can use the following passive probes without any limitations.

Passive probe	Recommended usage
P5100	High-voltage probe, 2500 V _{pk} CAT II, 250 MHz, 100X
P6015A	High-voltage probe, 20 kV DC, 75 MHz, 1000X
P6021	Current probe, 15 A, 120 Hz to 60 MHz
P6022	Current probe, 6 A, 935 Hz to 120 MHz
P6158	Low capacitance probe, 3 GHz, 20X (50 Ω)

Supported Active Probes and Adapters

The oscilloscope supplies power to active probes. You can use the following active probes as long as the total power required by the probes does not exceed the capacity of the oscilloscope. To determine the total probe load, add the load factors for all probes you want to use. The oscilloscope can supply power to this combination if the sum of the load factors equals 10 or less. All passive probes have a load factor of zero.

Active probe	Recommended usage	Load factor
P6205	FET probe, 750 MHz, 10X	0
P6243	SMT probe, 1 GHz, 10X	0
P5205	High-voltage differential probe, 1300 V, 100 MHz, 50X or 500X	6
P5210	High-voltage differential probe, 5600 V, 50 MHz, 100X or 1000X	6
ADA400A	Differential preamplifier, 10 μ V sensitivity, DC to 10 kHz	5
AMT75	Telecom 75 Ω adapter	0
TCP202	Current probe, 15 A, DC to 50 MHz	4
013-0278-01	Video display clamp	5



CAUTION. *To avoid a measurement error, do not connect active probes with a combined load factor that is greater than 10. The signal distortion caused by such an overload can be subtle (reduced gain, dynamic range, or slew rate).*

Unsupported Probes

The TDS3000C oscilloscopes only support the probes listed in this chapter of the manual. The oscilloscope may not display a message when you connect an unsupported probe, so make sure that any probe you connect to the TDS3000C is supported.

Appendix E: General Care and Cleaning

General Care

Protect the oscilloscope from adverse weather conditions. The oscilloscope is not water resistant.

Do not store or leave the oscilloscope where the LCD display will be exposed to direct sunlight for long periods of time.



CAUTION. *To avoid damage to the oscilloscope, do not expose it to sprays, liquids, or solvents.*

Cleaning

Inspect the oscilloscope as often as operating conditions require. To clean the oscilloscope exterior, follow these steps:

1. Remove loose dust on the outside of the oscilloscope with a lint-free cloth. Use care to avoid scratching the glass display filter.
2. Use a soft cloth or paper towel dampened with water to clean the oscilloscope. You can use a 75% isopropyl alcohol solution for more efficient cleaning.



CAUTION. *To avoid damage to the surface of the oscilloscope, do not use any abrasive or chemical cleaning agents.*

Appendix F: Ethernet Setup

This appendix describes how to set up the TDS3000C Series oscilloscope for network hard copy printing, and remote programmability or access. The TDS3000C requires a straight-through 10BaseT cable with an RJ-45 connector to connect to a LAN, or a crossover cable to connect to a PC equipped with an Ethernet card.

To connect to the oscilloscope through the Ethernet port, follow these steps:

1. Power off the oscilloscope.
2. Connect an Ethernet cable to the Ethernet port on the oscilloscope.
3. Power on the oscilloscope.

Your Ethernet Network Information

To connect the oscilloscope to the network, you must first obtain information from your network administrator. For your convenience, use the form at the end of this appendix.

Make two photocopies of the form and send them to your network administrator to fill in. If you require remote access to the oscilloscope for programming or e*Scope access, then have the network administrator fill in section 1. If you require your oscilloscope to print screen hard copies to a network printer, then have the network administrator fill in sections 1 and 2. The administrator can then return one copy to you and keep the other copy.

NOTE. *If the DHCP/BOOTP server assigns a dynamic IP address, then the value in the Instrument IP Address field may be different each time you power on the oscilloscope. This is not a problem if you are mostly sending hard copy to a network printer.*

However, if you intend to remotely control or access the oscilloscope, have the system administrator assign a static IP address so that the oscilloscope IP address does not change. A static IP address makes it easier for remote devices to access a specific oscilloscope.

Entering the Ethernet Network Settings

The procedure for entering the oscilloscope Ethernet network parameters depends on your network configuration.

Networks That Support DHCP and BOOTP

If your network supports DHCP/BOOTP, follow these steps:

1. Push the **Utility** front panel button.
2. Push the **System** menu button to select I/O.
3. Push the **Ethernet Network Settings** screen button.
4. Push the **DHCP/BOOTP** side button to select **On**. The screen displays the clock icon while it is talking with the network to obtain an IP address for the oscilloscope. This step should only take a few moments, but the actual time will vary depending on your network. The clock icon disappears when the task is finished.
5. To verify that the network assigned an IP address to the oscilloscope, push the **Change Instrument Settings** side button to display the oscilloscope ethernet settings. The oscilloscope IP address field should now be filled in.

NOTE. *If the oscilloscope IP address field is blank, then the oscilloscope was not able to obtain an IP address from the network. Contact your network administrator for help, or use the next procedure to manually enter the Ethernet settings.*

Networks That Do Not Support DHCP and BOOTP

If your network does not support DHCP or BOOTP protocols, you will need to manually enter the oscilloscope network settings. To enter the Ethernet network settings information from section 1 of the form, follow these steps:

1. Push the **Utility** front panel button.
2. Push the **System** bottom button to select **I/O**.
3. Push the **Ethernet Network Settings** bottom button.
4. Push the **Change Instrument Settings** side button. The oscilloscope displays the Instrument Setup screen.
5. Use the Instrument Setup screen menu items and controls to enter the network settings information from section 1 of the form. (See page 190, *The Instrument Setup Screen*.)
6. When you are done entering the Ethernet network settings, push the **OK Accept** side button to store the settings in your oscilloscope.
7. If the form shows that DHCP or BOOTP are supported on your network, push the **DCHP/BOOTP** side button to select **On**.

Entering the Network Printer Settings

To enter the Ethernet printer settings information from section 2 of the form into your oscilloscope, follow these steps:

1. Push the **Utility** front panel button.
2. Push the **System** bottom button to select **I/O**.
3. Push the **Ethernet Printer Settings** bottom button. The oscilloscope displays the Printer Configuration screen, which lists all network printers loaded into the oscilloscope.
4. Push the **Add Printer** side button. The oscilloscope displays the Add Printer screen.
5. Use the Add Printer screen menu items and controls to enter the network printer information from section 2 of the form. (See page 193, *The Add Printer Screen*.)

NOTE. *If you have set the domain name and DNS IP address in the Ethernet Network Settings menu, then all you need to enter is the network printer's server name or the printer's server IP address in the Add Printer screen. The DNS server will look up the missing information.*

6. When you are done entering the Ethernet printer settings, push the **OK Accept** side button to store the settings in your oscilloscope. The oscilloscope returns you to the Printer Configuration screen, which lists the printer information you just entered. You can enter and store multiple network printer parameters.

Testing Your Ethernet Connection

You must already have entered the oscilloscope Ethernet network and printer settings before you test the Ethernet connection, network printing, and the e*Scope feature.

Testing the Oscilloscope Connection

To test your oscilloscope's Ethernet connection, follow these steps:

1. Push the **Utility** front panel button.
2. Push the **System** bottom button to select **I/O**.
3. Push the **Ethernet Network Settings** bottom button to display the Network Configuration side menu.
4. Push the **Test Connection** side button. If the connection is good, the side menu displays **OK**. If you do not see **OK**, refer to the troubleshooting suggestions. (See page 190, *Troubleshooting Your Ethernet Connection*.)

Testing Network Printing

To test sending screen hard copy images to an Ethernet network printer, follow these steps:

1. On the oscilloscope, push **Utility > System : I/O > Ethernet Printer Settings**.
2. Select a network printer from the list.
3. Push the **System** bottom button to select **Hardcopy**.
4. Push the appropriate bottom and side menu buttons to select the correct settings for your network printer.
5. Push **Menu Off** to clear the screen.
6. Push the **Hard Copy** button. The oscilloscope sends a hard copy screen image to the selected network printer. If the printer does not print the oscilloscope screen, refer to the troubleshooting suggestions. (See page 190, *Troubleshooting Your Ethernet Connection*.)

Testing e*Scope

To use the e*Scope feature to test your oscilloscope's Ethernet connection, follow these steps:

1. On a PC or work station, open your preferred browser program.
2. In the Location or Address field (where you normally enter a URL), type in the IP address of the TDS3000C Series oscilloscope to which you want to connect. For example, <http://188.121.212.107>. Do not precede the IP address with any characters (such as *www*).
3. Push the **Return** key. The browser program loads the oscilloscope's e*Scope home page. If the e*Scope home page does not display, refer to the troubleshooting suggestions. (See page 190, *Troubleshooting Your Ethernet Connection*.)

Troubleshooting Your Ethernet Connection

If you are not able to remotely access the oscilloscope using e*Scope or programming commands, work with your system administrator to verify that:

- Your oscilloscope is physically connected to the network.
- Your oscilloscope network settings are correct.
- Your system administrator can "ping" the oscilloscope to verify that the oscilloscope is electronically connected to the network.

If you are not able to send a hard copy to a network printer, work with your system administrator to verify that:

- You have set the oscilloscope to send hard copy output to the Ethernet port.
- You have set the hard copy file format to the correct format for your network printer.
- You have selected the correct printer in the Printer Configuration screen.
- The selected network printer is connected to the network and is online.
- The selected network printer server is running.

The Instrument Setup Screen

The next figure shows the Instrument Setup screen. The text that follows describes the screen menu items and controls for entering Ethernet network settings.

Tek Run | Trig'd

Ethernet Address: 08:00:11:17:80:01
 Instrument Name: rgj_3054B
 User Password:
 Instrument IP Address: 128.181.216.207
 Domain Name:
 DNS IP Address:
 Gateway IP Address: 128.181.216.1
 Subnet Mask: 255.255.248.0
 Http Port: 80

Push 'OK Accept' to apply the changes and return to the previous menu.
 Push MENU OFF to cancel the changes and return to the previous menu.

aBCDEFGHIJKLMNOPQRSTUVWXYZ
 abcdefghijklmnopqrstuvwxyz
 0123456789_+~!@#%&*()[]<> / ~' " \ ; , . ?

Enter Character | + | - | Back Space | Delete | Clear

Instrument Setup
 ↑
 ↓
 OK Accept

HTTP Port

The HTTP Port field sets the network http socket value for the oscilloscope. This field lets you set up the oscilloscope as an e*Scope web server on a port other than the default port 80. This is useful for avoiding conflicts with existing web servers that use the same IP address through a router. The default value is 80.

Instrument Setup

Control	Description
General purpose knob	Selects (highlights) an alphanumeric character in the list.
Enter Character	Adds the selected alphanumeric character to the current network parameter field. You can also use the front panel Select button. The list of available characters changes depending on which field is selected.
← and →	Moves the cursor left or right in the current field.
Back Space	Erases the character to the left of the cursor.
Delete	Erases the character at the cursor position.
Clear	Clears (erases) the current field.
↑ and ↓	Selects a field to edit.

Instrument Setup Control	Description
OK Accept	Closes the Instrument Setup screen and applies the network settings.
Menu Off	Closes the Instrument Setup screen and returns you to the previous screen without applying changes.

The Printer Configuration Screen

The next figure shows the Printer Configuration screen.

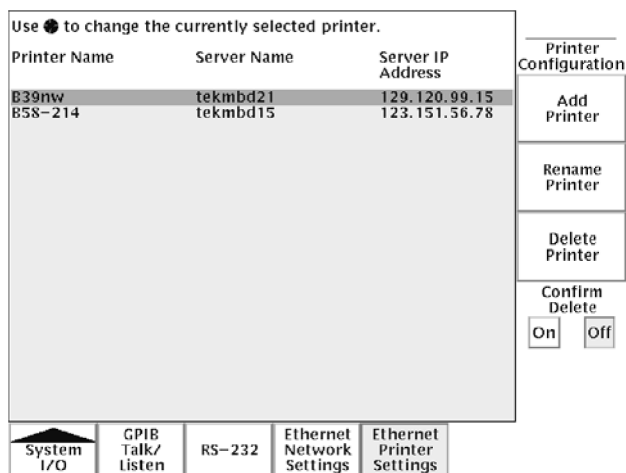

To select a network printer to which to send hard copy, use the general purpose knob to select (highlight) a printer. The oscilloscope uses the selected printer until you select a different printer.

To add a new printer, push the **Add Printer** side button. The oscilloscope displays the Add Printer screen. (See page 193.)

To rename an existing printer, select a printer and push the **Rename Printer** side button.

To delete a printer, select a printer and push the **Delete Printer** side button. If the **Confirm Delete** button is On, the oscilloscope asks you for confirmation before deleting the printer.

The Add Printer Screen

The next figure shows the Add Printer screen. The text that follows describes the screen menu items and controls for entering printer configuration settings.

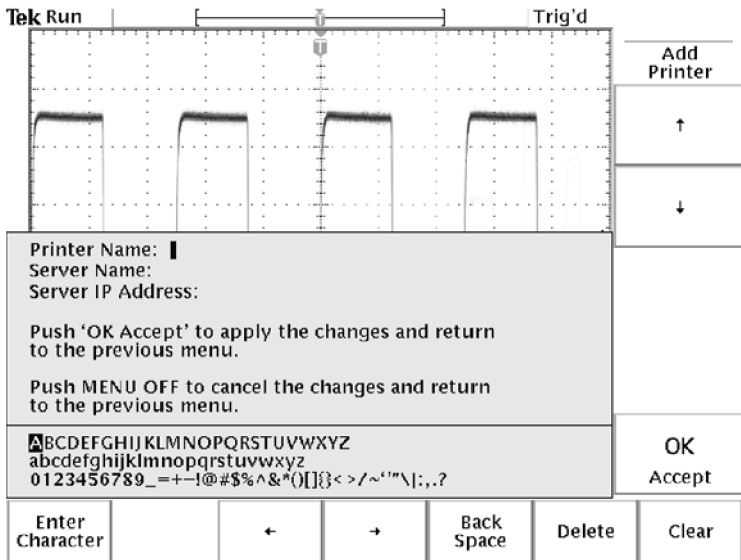

Add Printer Control	Description
General purpose knob	Selects (highlights) an alphanumeric character in the list.
Enter Character	Adds the selected alphanumeric character to the current printer setting field. You can also use the front panel Select button. The list of available characters changes depending on which field is selected.
← and →	Moves the cursor left or right in the current field.

Add Printer Control	Description
Back Space	Erases the character to the left of the cursor.
Delete	Erases the character at the cursor position.
Clear	Clears (erases) the current field.
↑ and ↓	Selects a field to edit.
OK Accept	Closes the Add Printer screen and applies the printer settings. You can use the new printer immediately.
Menu Off	Closes the Add Printer screen and returns you to the previous screen without applying changes.

Other Network Printer Settings

To verify that your oscilloscope is set to print to a network printer, follow these steps:

1. Select a network printer in the Ethernet printer list. You select a printer by using the general purpose knob to highlight a printer name in the list.
2. Push the **Menu Off** button to exit from the System I/O menus.
3. Push **Utility > System** to select **Hard Copy**.
4. Push the **Format** bottom button and select the side button that is correct for your network printer.
5. Push the **Port** bottom button and select the **Ethernet** side button.
6. Set Inksaver to **ON** to print the oscilloscope screen as a black on white background image.
7. Push the **Menu Off** button to exit from the System Hard Copy menus.

Testing Network Printers

To test that your oscilloscope is set to print to a network printer, push the Hard copy button. The printer should print the current screen to the selected network printer. If the printer does not print the screen, refer

to the troubleshooting suggestions. (See page 190, *Troubleshooting Your Ethernet Connection*.)

Ethernet Error Messages

The following error messages can occur when you are having network problems. Read the text that follows to help rectify the problem.

Print Server Not Responding. This notifier displays when the oscilloscope attempts to send data to the selected network printer but the network refuses the connection to the network printer. This usually means that the network printer server is offline or the print server IP address is incorrect.

If DNS is available then you can verify the network print server data by entering the printer name and either (but not both) the print server name or the IP address. The DNS protocol will fill in the missing data if the user-supplied data is correct.

If DNS is not available, then contact your network administrator for help.

Printer Not Responding. This notifier displays when the oscilloscope attempts to send data to the selected network printer but the print server is unable to forward the data to the network printer. This usually means that the network printer is offline or the printer name is incorrect. Contact your network administrator to obtain the correct printer queue name.

DNS Server Not Responding. This notifier displays when either the Domain information (Domain name or IP address) is not correct, or the print server name or printer server IP address is not validated (via the Domain Name Server).

Ethernet Settings Form

TDS3000C Ethernet Setup Form for: _____

TDS3000C Ethernet Hardware address ____ : ____ : ____ : ____ : ____ :

(Copy this address from the **Utility > System: I/O > Ethernet Network Settings > Change Instrument Setup** screen before sending this form to the network administrator.)

Type of IP address requested: **Dynamic (DHCP/BOOTP)** - **Static** -

(Refer to the beginning of this appendix for information on dynamic and static IP addresses. (See page 185, *Ethernet Setup*.)

1 IP address settings (from network admin.):

Instrument Name: _____

Instrument (IP) Address: ____ . ____ . ____ . ____

Domain Name: _____

DNS IP Address: ____ . ____ . ____ . ____

Gateway IP Address: ____ . ____ . ____ . ____

Subnet mask: ____ . ____ . ____ . ____

HTTP Port: _____

(Enter these values on the **Utility > I/O > Ethernet Network Settings > Change Instrument Settings** screen.) (See page 185, *Ethernet Setup*.)

2 Network Administrator: Please provide network information about the following printer:

Printer Location: _____

Printer Make: _____

Model: _____

(User: fill in above printer information before sending form)

Printer Network Name: _____

Printer Server Name: _____

Print Server IP Address: ____ . ____ . ____ . ____

(Enter the above information on the **Utility > I/O > Ethernet Printer Settings > Add Printer** screen.)

Index

A

- acquisition,
 - menu, 62
 - modes, 64
 - overview, 5
 - rate, 67
 - resolution, 67
 - single shot, 51, 60
 - status, 59
 - stopped, 59
 - waiting for trigger, 59
- active cursor, 72
- adjusting probes, 3
- advanced analysis application module, 170
- alternating trigger, 114
- amplitude measurement, 99
- application examples, 31
 - autoset, 32
 - averaging, 39
 - cursors, 40
 - custom measurements, 35
 - delay, 41
 - detecting distortion, 45
 - FFT measurements, 45
 - gray scale, 50
 - identifying the source of noise, 46
 - measurements, 32, 34
 - measuring jitter, 43
 - peak detect, 39
 - saving to a USB flash drive, 54
 - single shot signal, 51
 - video, 47
 - zoom, 53

- application modules,
 - descriptions, 170
 - installing, 15
- application packages,
 - descriptions, 170
 - installing, 15
- area measurement, 100
- Autoset, 60
 - button, 23
 - undo, 61
- averaging, 64

B

- B Trig button, 23
- B trigger,
 - how to use, 110
- backlight,
 - intensity, 75
 - time out, 133
- bandwidth selection, 140
- battery,
 - charging, 14, 171
 - installation, 13
 - power, 11
 - safety, 12
- burst width measurement, 99

C

- calibration, 4, 137
- channel button, 23
- cleaning, 183
- clear spool, 80
- Coarse button, 22
 - how to use, 72

- color,
 - display, 76
 - printing, 79
- communication module,
 - description, 170
 - installing, 16
- compressing hard copy files, 79
- constellation diagram, 77
- cursors,
 - application example, 40
 - gating, 37, 97
 - interactions, 98
 - locating, 72, 75
 - measurements when cursors at same position, 73
 - measurements, 40
 - readouts, 73
 - tracking mode, 73
 - V Bars and FFT
 - measurements, 73
 - XY cursor menu, 74
 - YT cursor menu, 70
- cycle area measurement, 100
- cycle mean measurement, 100
- cycle RMS measurement, 100

D

- date setting, 4
- date/time,
 - how to use, 133
- Delay button, 23, 82
- delay measurement, 98
- delay,
 - example application, 41
 - how to use, 82
 - interactions, 83, 85–86
- deskew, probe, 141

- detecting distortion,
 - application example, 45
- diagnostics, 138
- digital phosphor, 61
- display,
 - colors, 76
 - identifying items in, 24
 - menu, 75
 - overview, 6
 - persistence, 76
 - roll mode, 86
 - slow horiz. settings, 85

E

- e*Scope, 143
- edge trigger, 113
- envelope, 64
- error log, 138
- Ethernet setup, 185
- extended video application module, 170
- external trigger, 114

F

- factory calibration, 137
- factory setup,
 - detailed description, 165
- fall time measurement, 99
- fast trigger, 67
- FFT measurements,
 - detecting distortion application example, 45
 - identifying the source of noise application example, 46
- file compression, hard copy, 79

file system,
 application example, 54
 extensions, 107
 formatting a USB flash
 drive, 107
 how to use, 104
 protections, 107
 waveform data formats, 102
firmware update,
 internet, xi
Force Trig button, 23, 109
frequency measurement, 98
front panel,
 connectors, 28
 controls, 20
functional check, 2

G

gated xyz, 77
General Purpose knob, 22
GPIO, 136
 communication module, 170
gray scale,
 application example, 50
 controlling, 61
 losing information, 85
 measurements, 73
 restrictions, 87, 143
.gz file format, 79

H

Hard Copy button, 24
hard copy file compression, 79
hard copy, *See* printing
high measurement, 99
holdoff, 115
horizontal preview,
 application example, 52
 interactions, 84

horizontal zoom,
 application example, 53
 how to use, 84
 interactions, 84
 maximum, 84
horizontal,
 expansion marker, 82
 Position knob, 23
 position, 81
 resolution, 67
 Scale knob, 23
 scale, 83
 ZOOM button, 23

I

I/O ports, 135
initial setup, 1
ink saver, 79

L

language,
 how to select, 132
limit test application module, 170
logic trigger, 119, 121
low measurement, 99

M

magnify, *See* zoom
Math button, 23
math waveform, 86
math,
 preview, 87
 source waveform screen
 position, 87
max measurement, 99
mean measurement, 100
measurement,
 overview, 7

measurements,
 automatic, 98
 cursor, 40
 gating, 37, 97
 interactions, 96
 menu, 95
 reference levels, 36
 V Bars and FFT, 73

Menu Off button, 24

menus,

 how to use, 18

min measurement, 100

N

negative measurement,
 duty cycle, 99
 overshoot, 99
 width, 99

noise source and identifying,
 application example, 46

O

Off button, 23

P

pattern trigger, 119

peak detect, 64

peak-to-peak measurement, 99

period measurement, 98

persistence, 76

phase measurement, 99

positions for operation, 10

positive duty cycle measurement, 99

positive overshoot measurement, 99

positive width measurement, 99

power cord, 10

power off timeout, 133

power,

 AC line, 10

 battery, 11

 probe, 180

 switch, 24

pretrigger, 81

preview,

 application example, 52

 horizontal, 84

 vertical, 141

printing,

 color, 79

 connections, 78

 date/time stamp, 80

 error message, 80

 hard copy file compression, 79

 ink saver, 79

 preview, 79

 printer compatibility, 78

 spooler, 80

probe deskew, 141

probes,

 compensating, 3

 general information, 173

 power limitations, 180

 safety information, 174

product description,

 models, 5

 overview, 5

 probes, 180

pulse width trigger, 122

Q

QuickMenu, 26

 how to use, 101

 identifying menu items, 26

R

- readouts,
 - cursors, 73
- rear panel,
 - connectors, 29
- record length, 67
- Ref button, 23
- reference,
 - scale and position, 87, 143
 - waveforms, 142
- remote control, e*Scope, 143
- removing waveforms, 139
- rise time measurement, 99
- RMS measurement, 100
- roll mode, 86
- RS-232,
 - communication module, 170
 - troubleshooting, 136
- Run/Stop button, 23, 59
- runt pulse trigger, 125

S

- safety for battery operation, 12
- Safety Summary, iii
- sample, 64
- save/recall,
 - menu, 101
 - setups, 102
 - waveforms to file, 102
 - waveforms to ref memory, 103
 - waveforms, 142
- saved waveforms,
 - naming, 105
 - printing, 106
- Select button, 22, 72
- self test, 138

- Set To 50% button, 23, 109
- signal path compensation, 4, 137
- signal processing,
 - overview, 6
- signal threshold concepts, 116
- Single Seq button, 23, 60
- single shot, 60
 - application example, 51
- slew rate trigger, 127
- slow roll mode, 85
- snapshot all measurements, 100
- SPC, 4, 137
- specifications, 149
- state trigger, 121
- status,
 - acquisition, 59
 - trigger, 112
- stopped acquisition, 59

T

- TDS3BATC, 12
- TekProbe interface, 141, 174
- TekSecure,
 - how to use, 134
- telecom mask test application
 - module, 170
- threshold voltage concepts, 116
- time base,
 - controlling, 83
 - fast settings, 85
- time out, 133
- time setting, 4
- transport, 9
- trigger concepts,
 - threshold voltage, 116

trigger,
 alternating, 114
 auto, 114
 edge, 113
 external, 114
 holdoff, 115
 Level knob, 23
 level, 108
 logic, 119, 121
 menu, 108
 normal, 114
 overview, 7
 pattern, 119
 position marker, 81
 pulse width, 122
 runt pulse, 125
 slew rate, 127
 state, 121
 status, 112
 video, 130
 XY waveforms, 77

U

undo autose, 61
USB flash drive,
 application example, 54
 how to use, 104
 port, 24
utility menus, 132

V

vertical,
 channel button, 23
 Math button, 23
 menu, 86, 140, 142
 offset, 141
 Position knob, 22
 position, 139
 preview, 141
 Ref button, 23
 Scale knob, 23
 scale, 139
video modulation,
 application example, 50
video trigger, 130
 application example, 47
 sync pulse, 131

W

WaveAlert, 68
Waveform Intensity knob, 23, 61
waveform off, 139
 button, 23
waveforms,
 file formats, 107
 record icon, 25
 saving to file, 102
 saving to reference memory, 102
web-based remote control, 143
wrist strap ground, 24

X

XY waveform,
 controlling, 77
 gated xyz, 77
 restrictions, 77
 triggering, 77
XY, XYZ cursors, 74

Y

YT cursors, 70

Z

zoom,

application example, 53

how to use, 84

interactions, 84

maximum, 84